

ADYSS 

# PRODUCT LIST

FITRTECH

# PATENTED PRODUCTS

STACKED PRODUCTS | LEADING ERA FOLDING  
OPEN QUALITY OF LIFE



## EXPANDABLE PHONE STAND

In 2014, the first domestic research and development of multi-functional beauty fill light bracket, breakthrough traditional selfie stick limitations, upgrade the innovative shooting concept.

Invention Patent No.: 201910600590 .4



## FILL LIGHT

In 2018, the first domestic ALL-IN-ONE folding desk lamp developed, energy-saving eye protection, 360 ° rotation, 5000mah high-capacity battery, is a good partner for work and study.

Invention Patent No.: CN201910759824.X



## FOLDING FAN

In 2018, the first domestic research and development of the ALL-IN-ONE folding fan, portable, mobile use, home travel essential, to life more space fun.

Invention Patent No.: CN201910759811.2

# EXPANDABLE PHONE STAND

LIVE STREAMING | 360° SHOOTING  
TRAVEL SELFIE





# A35

## EXPANDABLE PHONE STAND

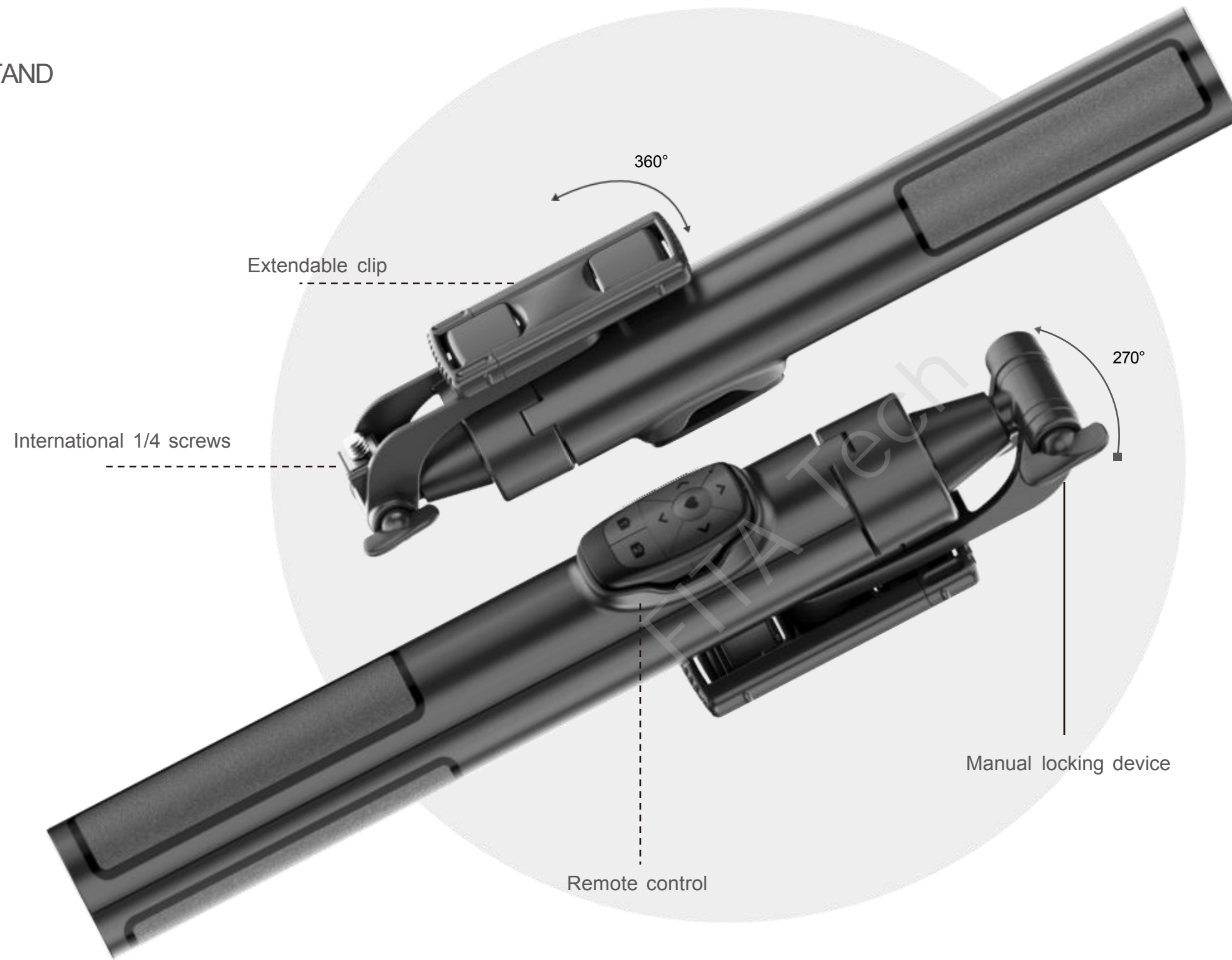

### FEATURE SELLING POINTS

- Remote control  
(Single button or Tiktok button)
- Can be added with  
1/4 screw compatible fill light

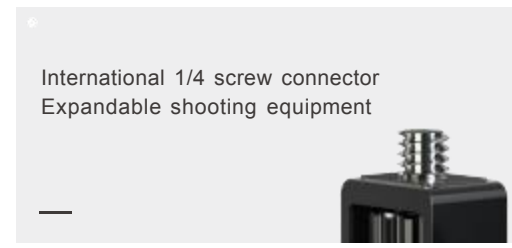
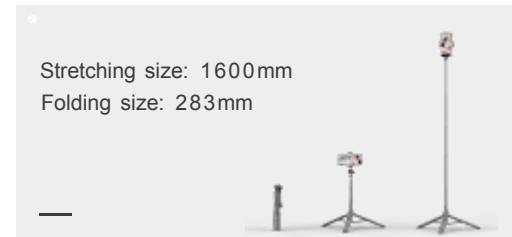

### PRODUCT PARAMETERS

- Expandable length: 1.6m  
(Customizable 1.7m, 2m)
- Available phone size: 4.7-7-inches
- Maximum load bearing capacity: 500g
- Main material: Stainless Steel & ABS plastic
- Support system: Android,IOS,HarmonyOS
- Folded size: 45\*59\*283mm
- Net weight: 278g
  
- Battery capacity(Remote control):  
55mAh(Rechargeable)/120mAh(Button)
- Standby time(Remote control): 360 days
- Working temperature: -20°~60C°
- Working voltage: 3.0V
- Charging voltage: DC 5V



# A36

## EXPANDABLE PHONE STAND



# A65

## EXPANDABLE PHONE STAND



### FEATURE SELLING POINTS

- Remote control  
(Single button or Tiktok button)
- Equipped with sub-handle  
for physical anti-sway & 360° panoramic photo
- Can be added with  
1/4 screw compatible ill light

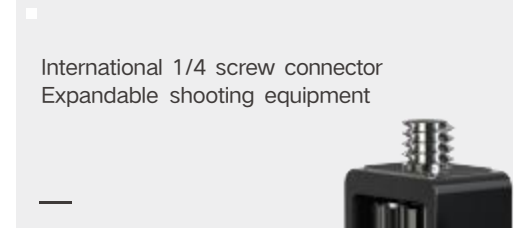

### PRODUCT PARAMETERS

Expandable length: 1.6m  
(A36 can be customized 1.7m, 2m)  
Available phone size: 4.7-7inches  
Maximum load bearing capacity: 500g  
Main material: Stainless Steel & ABS plastic  
Support system: Android,IOS,HarmonyOS  
Folded size: 45\*68\*290mm  
Net weight: 297.5g

Battery capacity(Remote control):  
55mAh(Rechargeable)/120mAh(Button)  
Standby time(Remote control): 360 days  
Working temperature: -20°~60C°  
Working voltage: 3.0V  
Charging voltage: DC 5V



# A66

## EXPANDABLE PHONE STAND

Remote control

Balanceable Handle

Charging port

Extendable clip

Aluminum alloy

Fill light

Retractable tripod

### FEATURE SELLING POINTS

- 360° rotatable head
- Equipped with Fill light
- Bottom retractable tripod
  
- Remote control  
(Single button or Tiktok button)
- Equipped with sub-handle for physical anti-sway & 360° panoramic photo
- Can be added with 1/4 screw compatible fill light

Stretching size: 1600mm  
Folding size: 290mm



International 1/4 screw connector  
Expandable shooting equipment



### PRODUCT PARAMETERS

Expandable length: 1.6m  
Available phone size: 4.7-7inches  
Maximum load bearing capacity: 500g  
Main material: Aluminum alloy & ABS plastic  
Support system: Android,IOS,HarmonyOS  
Folded size: 45\*98\*290mm  
Net weight: 322.5g

Battery capacity(Remote control):  
55mAh(Rechargeable)/120mAh(Button)  
Battery capacity(Fill light): 55mAh  
Working time(Fill light): 30min  
Charging time(Fill light): 60min  
Standby time(Fill light): 30 days  
Working temperature: -20°~60C°  
Working voltage: 3.6-4.2V  
Charging voltage: DC 5V





# A55S

## EXPANDABLE PHONE STAND



### FEATURE SELLING POINTS

- Remote control
- Equipped with sub-handle
- for physical anti-sway & 360 °panoramic photo
- Can be added with 1/4 screw compatible ill light

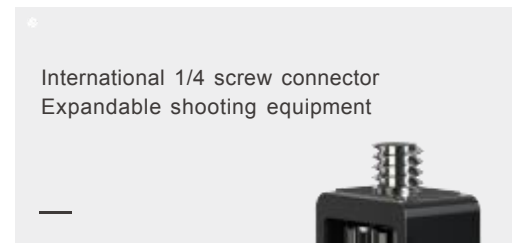
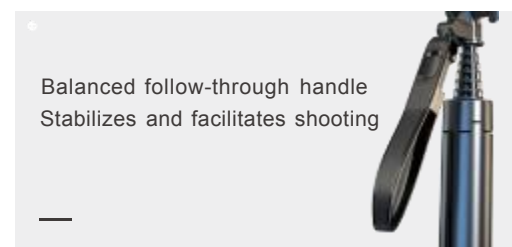

### PRODUCT PARAMETERS

- Expandable length: 1.75m
- Available phone size: 4.7-7 inches
- Maximum load bearing capacity: 500g
- Main material: Aluminum alloy & ABS plastic
- Support system: Android, IOS, HarmonyOS
- Folded size: 45\*73\*280mm
- Net weight: 250g
- Battery capacity(Remote control): 120mAh
- Standby time(Remote control): 360 days
- Working temperature: -20°~60°
- Working voltage: 3.0V
- Charging voltage: DC 5V 2A



# A301

## EXPANDABLE PHONE STAND

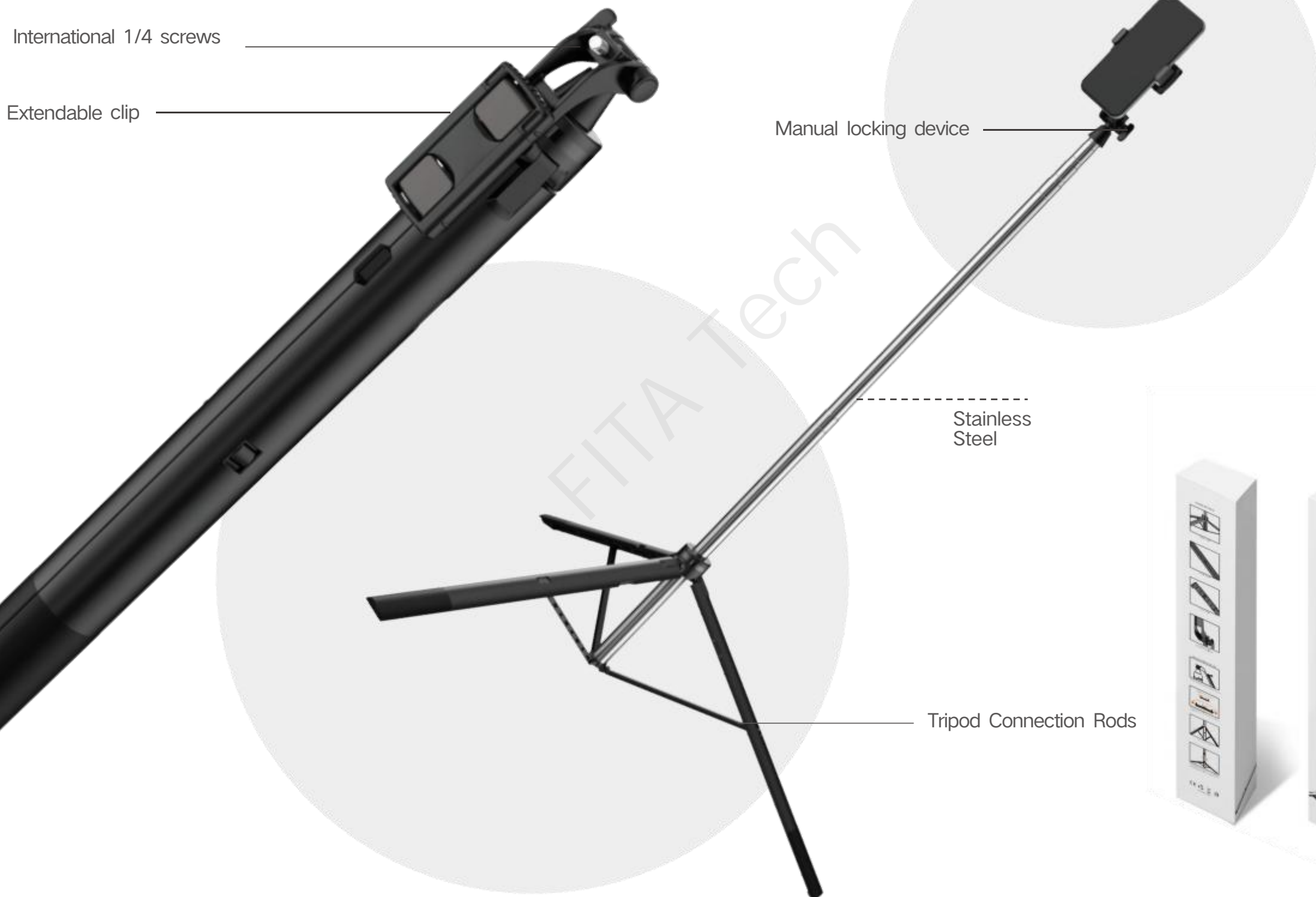

International 1/4 screws

Extendable clip

Manual locking device

Stainless Steel

Tripod Connection Rods



Stretching size: 1900mm  
Folding size: 460mm

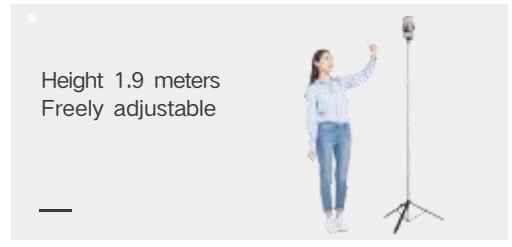

Height 1.9 meters  
Freely adjustable



International 1/4 screw connector  
Expandable shooting equipment

### PRODUCT PARAMETERS

- Expandable length: 1.9m (customized height:>2m)
- Available phone size: 4.7-7inches
- Maximum load bearing capacity: 500g
- Main material: Stainless Steel & ABS plastic
- Support system: Android,IOS,HarmonyOS
- Folded size: 42\*64\*460mm
- Net weight: 570g
- Battery capacity(Remote control): 120mAh
- Standby time(Remote control): 360 days
- Working temperature: -20°~60°
- Working voltage: 3.0V
- Charging voltage: DC 5V 2A

### FEATURE SELLING POINTS

- Remote control
- Can be added with 1/4 screw compatible ill light



# A21A

## EXPANDABLE PHONE STAND



### FEATURE SELLING POINTS

- Remote control
- Equipped with Fill light
- Iron support tripod
  
- Equipped with sub-handle for physical anti-sway & 360° panoramic photo
- Can be added with 1/4 screw compatible fill light

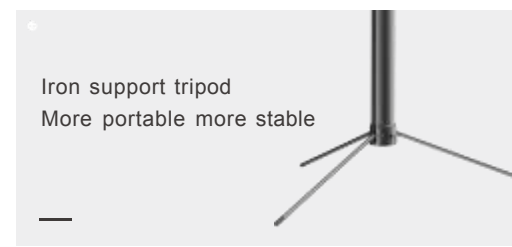

### PRODUCT PARAMETERS

- Expandable length: 1.7m
- Available phone size: 4.7-7inches
- Maximum load bearing capacity: 500g
- Main material: Aluminum alloy & ABS plastic
- Support system: Android,IOS,HarmonyOS
- Folded size: 45\*92\*289mm
- Net weight: 536.5g
  
- Battery capacity(Remote control): 55mAh(A19)
- Battery capacity(Fill light): 55mAh
- Working time(Fill light): 30min
- Charging time(Fill light): 60min
- Standby time(Fill light): 30 days
- Working temperature: -10°~40C°
- Working voltage: 3.6-4.2V
- Charging voltage: DC 5V



# A21S

## EXPANDABLE PHONE STAND

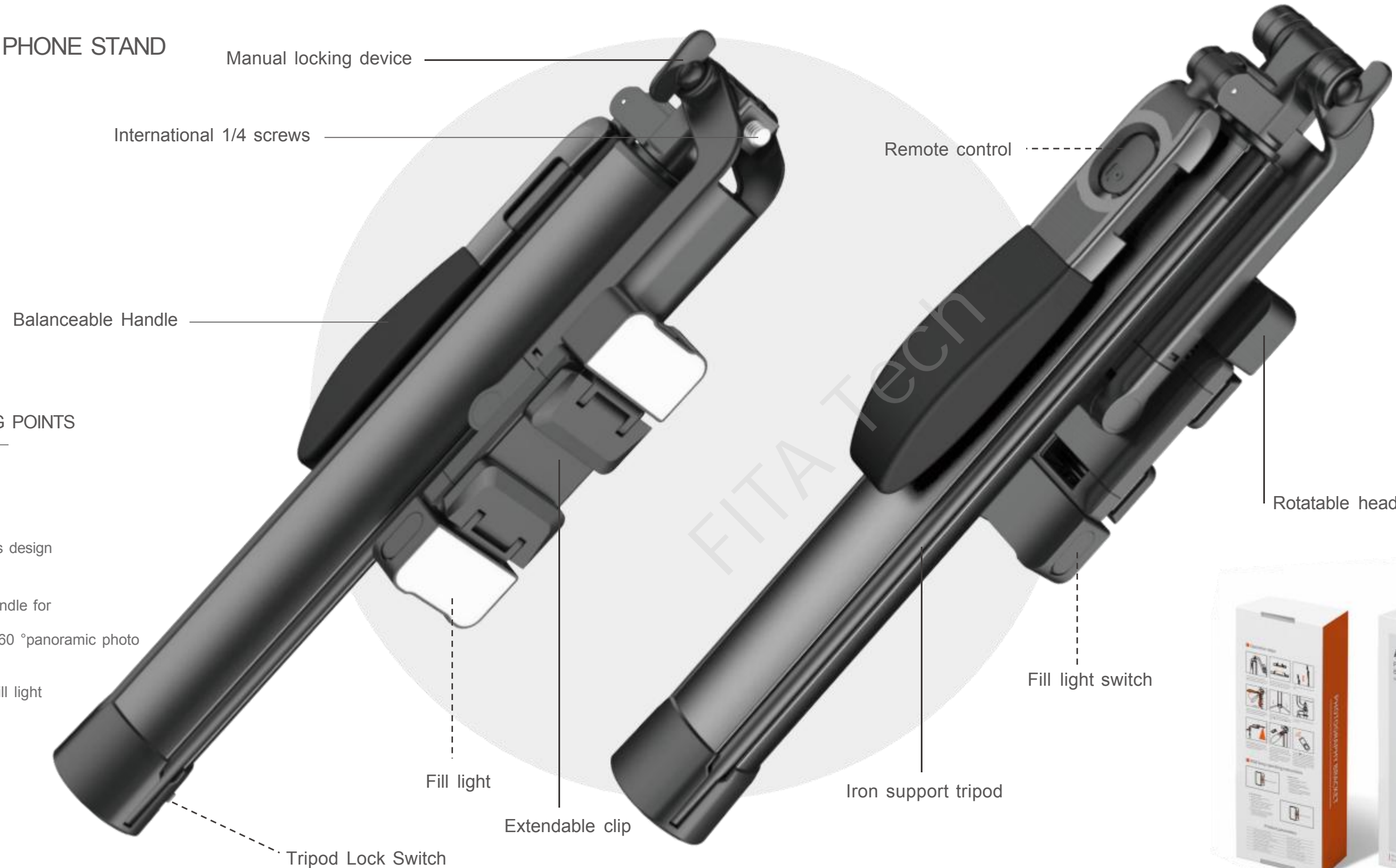

### FEATURE SELLING POINTS

- Remote control
- 360° rotatable head
- Iron support tripod
- RGB+Warm dual lights design
- Equipped with sub-handle for physical anti-sway & 360 °panoramic photo
- Can be added with 1/4 screw compatible ill light

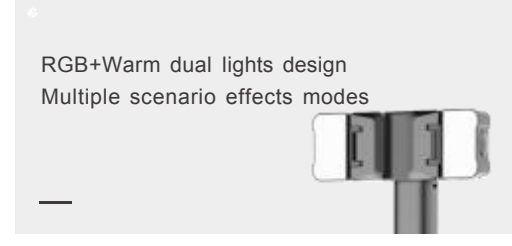
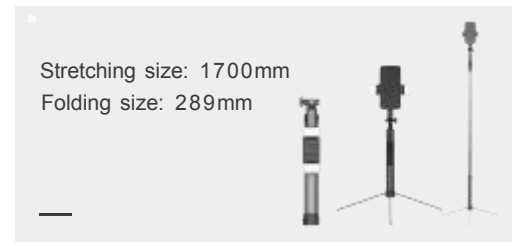

### PRODUCT PARAMETERS

- Expandable length: 1.7m
- Available phone size: 4.7-7inches
- Maximum load bearing capacity: 500g
- Main material: Aluminum alloy & ABS plastic
- Support system: Android,IOS,HarmonyOS
- Folded size: 45\*92\*289mm
- Net weight: 576.2g
- Battery capacity(Remote control): 55mAh(A19)
- Battery capacity(Fill light): 55mAh
- Working time(Fill light): 30min
- Charging time(Fill light): 60min
- Standby time(Fill light): 30 days
- Working temperature: -10°~40C°
- Working voltage: 3.6-4.2V
- Charging voltage: DC 5V





# A21P

## EXPANDABLE PHONE STAND

International  
1/4 screws

Extendable clip

Fill light

Fill light switch

Manual locking device

Remote  
control

Iron support tripod

Balanceable  
Handle

Stretching size:  
1700mm  
Folding size: 289mm



Clip rotatable  
Connecting arm rotatable



Tiktok remote control  
More convenient for video



### PRODUCT PARAMETERS

Expandable length: 1.7m  
Available phone size: 4.7-7inches  
Maximum load bearing capacity: 500g  
Main material: Aluminum alloy & ABS plastic  
Support system: Android,IOS,HarmonyOS  
Folded size: 45\*100\*289mm  
Net weight: 558.6g

Working temperature: -10°~40C°  
Working voltage: 3.6-4.2V  
Charging voltage: DC 5V  
Battery capacity(Remote control): 55mAh  
Battery capacity(Fill light): 55mAh  
Working time(Fill light): 30min  
Charging time(Fill light): 60min  
Standby time(Fill light): 30 days

### FEATURE SELLING POINTS

- Remote control (Tiktok)
- 360° rotatable head
- RGB+Warm dual lights design
- Iron support tripod
- Equipped with sub-handle for physical anti-sway & 360° panoramic photo
- Can be added with 1/4 screw compatible fill light





# A21M

## RECHARGEABLE & EXPANDABLE PHONE STAND



Remote control

Balanceable Handle

Extendable clip

International 1/4 screws

Type-C Charging Cable

Power bank

Fill light

Iron support tripod

Tripod Lock Switch

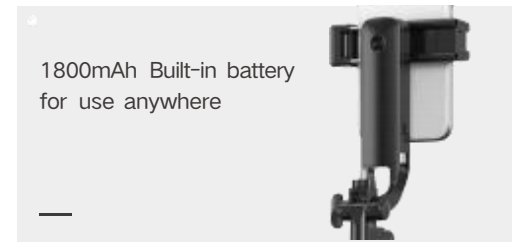

1800mAh Built-in battery for use anywhere

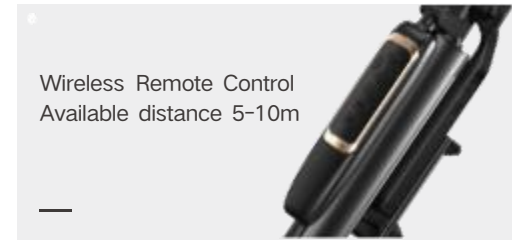

Wireless Remote Control Available distance 5-10m

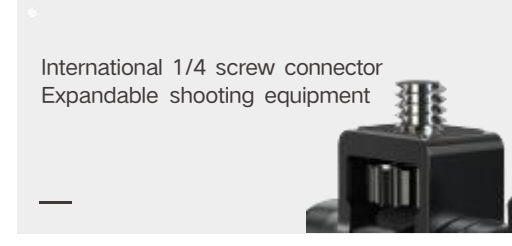

International 1/4 screw connector Expandable shooting equipment

### PRODUCT PARAMETERS

Expandable length: 1.7m  
Available phone size: 4.7-7inches  
Maximum load bearing capacity: 500g  
Main material: Aluminum alloy+ABS plastic  
Support system: Android、IOS、 HarmonyOS  
Folded size: 45\* 100 \*289mm  
Net weight: 610g

Battery capacity(Power bank): 1800mAh  
Battery capacity(Remote control): 55mAh  
Battery capacity(Fill light): 55mAh/300mAh(D2)  
Working time(Fill light): 30min  
Charging time(Fill light): 60min  
Standby time(Fill light): 30days  
Working temperature: -10°~40C°  
Working voltage: 3.6-4.2v  
Charging voltage: DC 5V

### FEATURE SELLING POINTS

- Remote control (Tiktok)
- RGB+Warm dual lights design
- Built-in battery for use anywhere
  
- Iron support tripod
- Equipped with sub-handle for physical anti-sway
- & 360 °panoramic photo
- Can be added with 1/4 screw compatible fill light

# A510

## EXPANDABLE PHONE STAND

Remote control

Balanceable Handle

Extendable clip

Charging port

Fill light

Manual locking device

Aluminum alloy

Retractable tripod

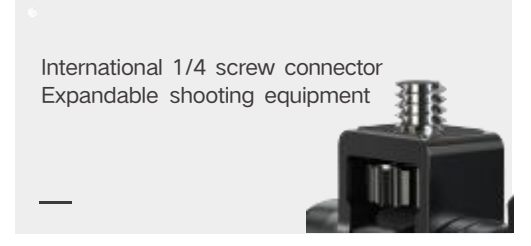
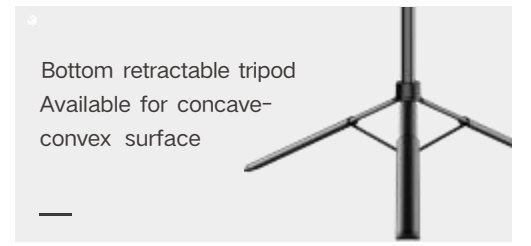

### FEATURE SELLING POINTS

- Remote control (Tiktok)
- Bottom retractable tripod
- 360° rotatable head

- Equipped with sub-handle for physical anti-sway & 360° panoramic photo
- Can be added with 1/4 screw compatible fill light

### PRODUCT PARAMETERS

Expandable length: 1.75m  
Available phone size: 4.7-7inches  
Maximum load bearing capacity: 500g  
Main material: Aluminum alloy & ABS plastic  
Support system: Android, IOS, HarmonyOS  
Folded size: 45\*102\*286mm  
Net weight: 381.5g

Battery capacity(Remote control): 55mAh  
Standby time((Remote control)): 30days  
Battery capacity(Fill light): 55mAh  
Working time(Fill light): 30min  
Charging time(Fill light): 60min  
Standby time(Fill light): 30days  
Working temperature: -10°~40C°  
Working voltage: 3.6-4.2v  
Charging voltage: DC 5V 2A

# A518

## EXPANDABLE PHONE STAND

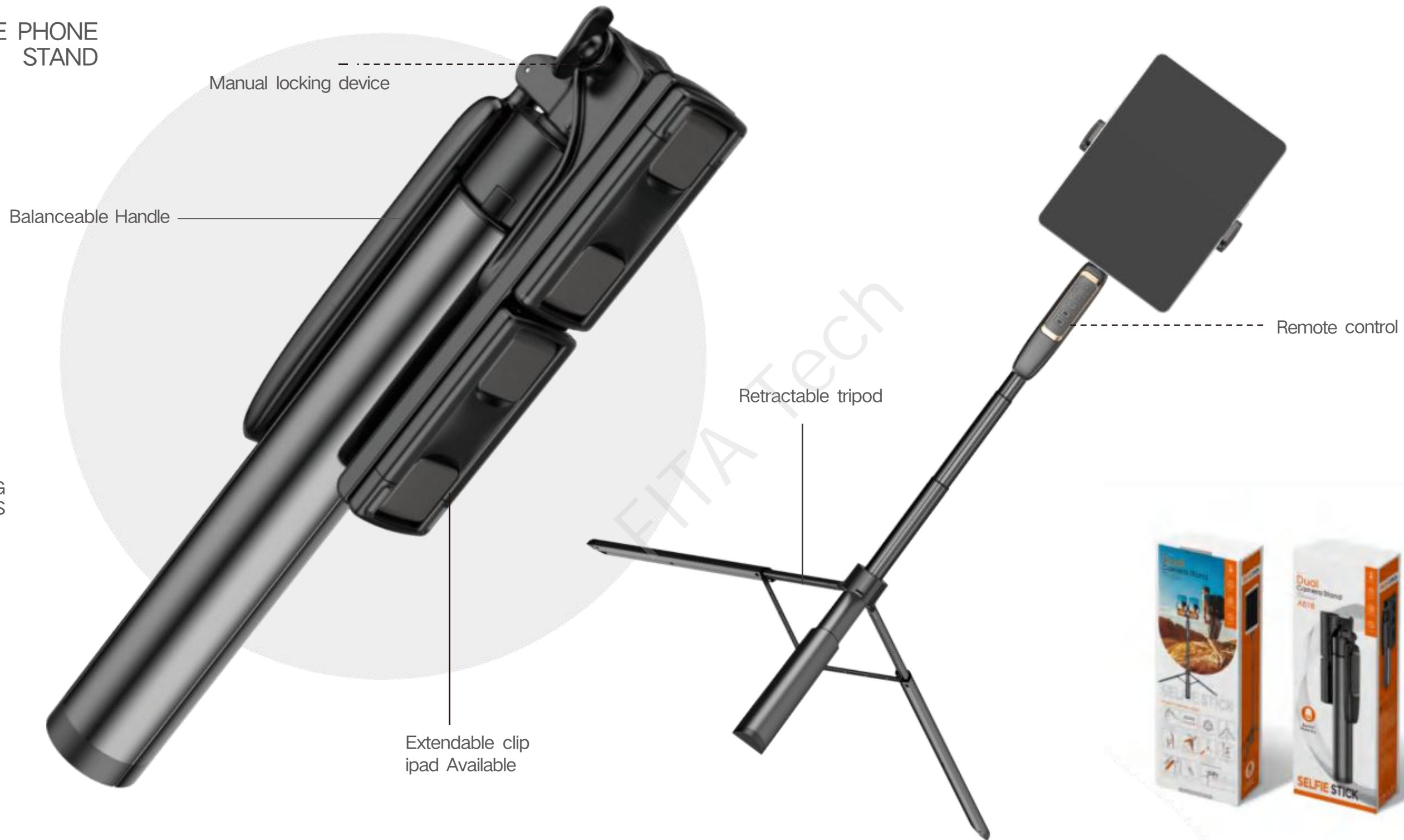

### FEATURE SELLING POINTS

- Remote control (Tiktok)
- Bottom retractable tripod
- Dual clips, Available phone size: 4.7-14.5 inches, ipad
- Equipped with sub-handle for physical anti-sway & 360° panoramic photo
- Can be added with 1/4 screw compatible ill light

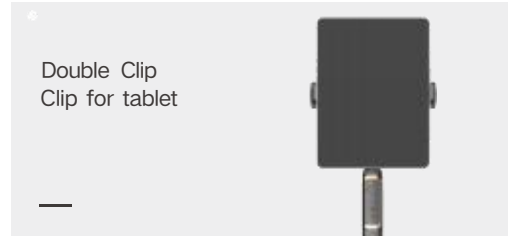

### PRODUCT PARAMETERS

Expandable length: 1.75m  
Available phone size: 4.7-14.5 inches  
Maximum load bearing capacity: 500g  
Main material: Aluminum alloy+ABS plastic  
Support system: Android, IOS, HarmonyOS  
Folded size: 45\*102\*286mm  
Net weight: 427.4g

Battery capacity(Remote control): 55mAh  
Standby time(Remote control): 30 days  
Working temperature: -10°~40°  
Working voltage: 3.6~4.2V  
Charging voltage: DC 5V 2A





# A33

MINI

## EXPANDABLE PHONE STAND



### FEATURE SELLING POINTS

- Detachable remote control
- Small and portable
- Lightweight construction
- Multi-size phone adaptation

# A33P

MINI

## EXPANDABLE PHONE STAND

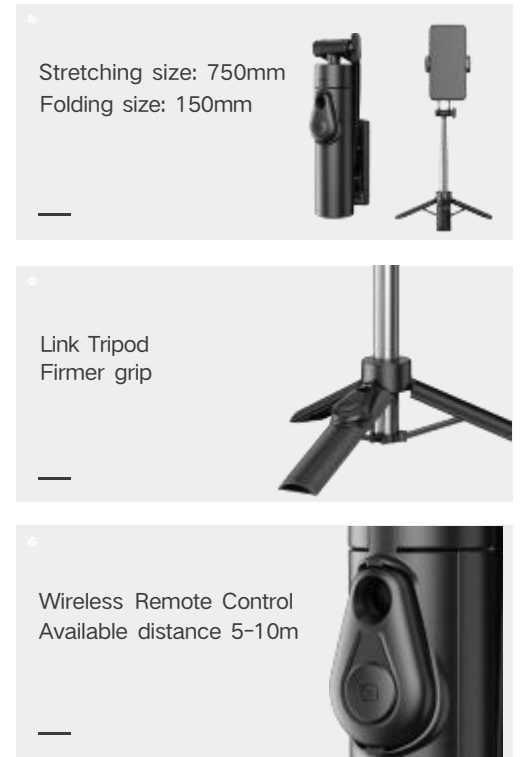

### PRODUCT PARAMETERS

A33/A33P  
 Available phone size: 4.7-7inches  
 Maximum load bearing capacity: 500g  
 Main material: Stainless Steel & ABS plastic  
 Support system: Android, IOS, HarmonyOS

Model: A33  
 Expandable length: 0.8m  
 Folded size: 45\*57\*150MM  
 Net weight: 143.5g

Model: A33P  
 Expandable length: 0.8m  
 Folded size: 36\*55\*150mm  
 Net weight: 143.5g

# A37

MINI

EXPANDABLE PHONE STAND



Extendable clip

Remote control

### FEATURE SELLING POINTS

- Detachable remote control
- Small and portable
- Lightweight construction
- Multi-size phone adaptation

# A37P

MINI

EXPANDABLE PHONE STAND



Extendable clip

Remote control



Stretching size: 1100mm  
Folding size: 200mm



Link Tripod  
Firmer grip



Wireless Remote Control  
Available distance 5-10m



### PRODUCT PARAMETERS

A37/A37P

Available phone size: 4.7-7inches

Maximum load bearing capacity: 500g

Main material: Stainless Steel & ABS plastic

Support system: Android, IOS, HarmonyOS

Model: A37

Expandable length: 1.1m/1.3m

Folded size: 45\*57\*200MM

Net weight: 186g(1.1)/193g(1.3)

Model: A37P

Expandable length: 1.1m/1.3m

Folded size: 36\*58\*200MM

Net weight: 187.5g(1.1)/194g(1.3)



# A63

MINI

EXPANDABLE PHONE STAND



Extendable clip

Remote control

### FEATURE SELLING POINTS

- Detachable remote control
- Small and portable
- Lightweight construction
- Multi-size phone adaptation

# A63P

MINI

EXPANDABLE PHONE STAND



Extendable clip

Remote control



Stretching size: 750mm  
Folding size: 150mm



Link Tripod  
Firmer grip

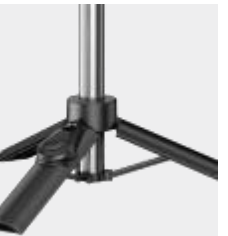

Wireless Remote Control  
Available distance 5-10m



### PRODUCT PARAMETERS

A63/A63P

Available phone size: 4.7-7inches

Maximum load bearing capacity: 500g

Main material: Aluminum alloy & ABS plastic

Support system: Android, IOS, HarmonyOS

Model: A63

Expandable length: 0.8m

Folded size: 45\*57\*150MM

Net weight: 135g

Model: A63P

Expandable length: 0.8m

Folded size: 35\*58\*150mm

Net weight: 141g



# A67

MINI

EXPANDABLE PHONE STAND

### FEATURE SELLING POINTS

- Detachable remote control
- Small and portable
- Lightweight construction
- Multi-size phone adaptation



Extendable clip

Remote control

# A67P

MINI

EXPANDABLE PHONE STAND

Extendable



Remote control

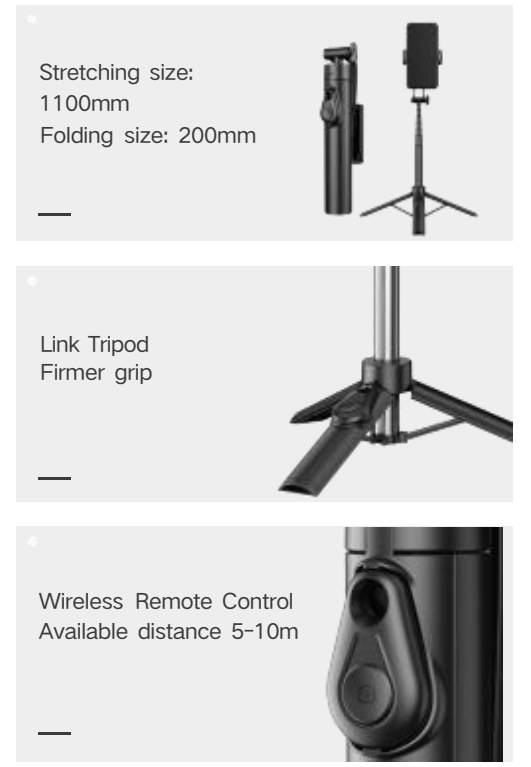

Stretching size: 1100mm  
Folding size: 200mm

Link Tripod  
Firmer grip

Wireless Remote Control  
Available distance 5-10m

### PRODUCT PARAMETERS

A67/A67P  
Available phone size: 4.7-7inches  
Maximum load bearing capacity: 500g  
Main material: Aluminum alloy & ABS plastic  
Support system: Android, IOS, HarmonyOS

Model: A67  
Expandable length: 1.1m  
Folded size: 43\*58\*200MM  
Net weight: 175g  
Model: A67P  
Expandable length: 1.1m/1.3m  
Folded size: 35\*60\*200MM  
Net weight: 180.5g(1.1)/184.5g(1.3)

# A67P-C

## MAGNETIC EXPANDABLE PHONE STAND

Magnetic clip

### FEATURE SELLING POINTS

- Remote control  
(For iPhone 12 and above)
- Phone clip with magnetic suction



Anti-slip handle

Aluminum alloy

Remote control

Tripod Connection Rods

Stretching size: 1300mm  
Folding size: 220mm



Wireless Remote Control  
Available distance 5-10m



Link Tripod  
Firmer grip



### PRODUCT PARAMETERS

Expandable length: 1.3m  
Available phone size: 4.7-7inches  
Maximum load bearing capacity: 500g  
Main material: Aluminum alloy & ABS plastic  
Support system: Android, IOS, HarmonyOS  
Folded size: 220\*71\*80MM  
Net weight: 245g

Battery capacity(Remote control): 120mAh  
Standby time((Remote control)): 30days  
Working temperature: -10°~40C°  
Working voltage: 3.6-4.2v  
Charging voltage: DC 5V 2A

# A900

## ALL-IN-ONE EXPANDABLE PHONE STAND

### FEATURE SELLING POINTS

- Remote control
- RGB+Warm light design
- ALL-IN-ONE design
- Equipped with sub-handle for physical anti-sway & 360 ° panoramic photo

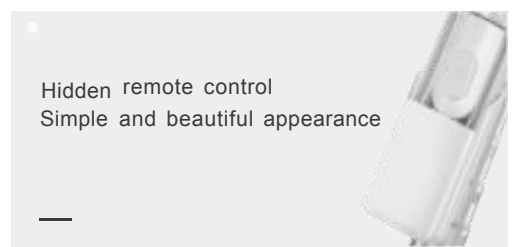
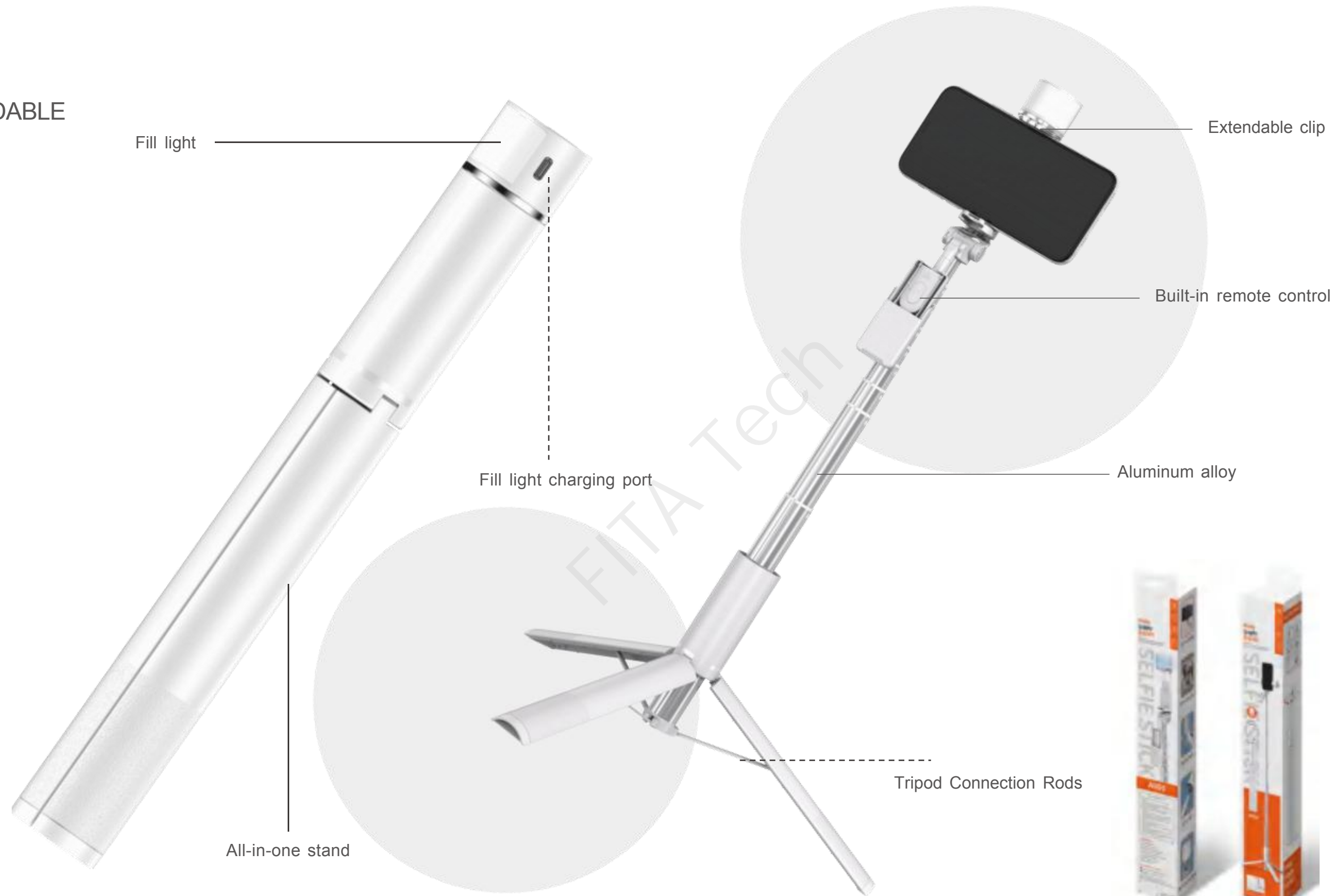

### PRODUCT PARAMETERS

- Color: Black/White
- Expandable length: 1.5m
- Available phone size: 4.7-7 inches
- Maximum load bearing capacity: 500g
- Main material: Aluminum alloy+ABS plastic
- Support system: Android,IOS, HarmonyOS
- Folded size: 37\*37\*313mm
- Net weight: 307g
- Battery capacity(Remote control): 120mAh
- Battery capacity(Fill light): 55mAh
- Working time(Fill light): 30min
- Charging time(Fill light): 50 min
- Standby time(Fill light): 30 days
- Working temperature: -10~40C°
- Working voltage: 3.6-4.2v
- Charging voltage: DC 5V





# A900E

## ALL-IN-ONE EXPANDABLE PHONE STAND

Remote control

Extendable clip

Aluminum alloy

Tripod Connection Rods

### FEATURE SELLING POINTS

- Remote control
- ALL-IN-ONE design

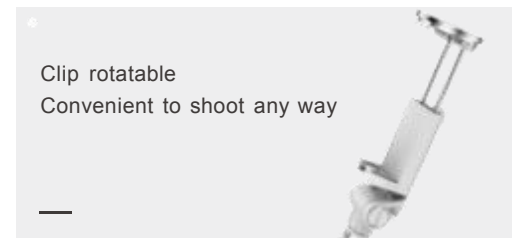
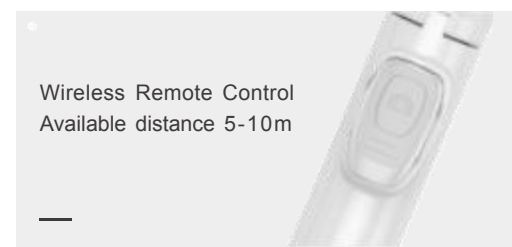

### PRODUCT PARAMETERS

Expandable length: 1.5m  
Available phone size: 4.7-7 inches  
Maximum load bearing capacity: 500g  
Main material: Aluminum alloy+ABS plastic  
Support system: Android,IOS, HarmonyOS  
Folded size: 37\*37\*290mm  
Net weight: 263g

Battery capacity(Remote control):  
120mAh(Button)  
Working temperature: -10~40C°  
Working voltage: 3.6-4.2v  
Charging voltage: DC 5V



# S1

## MOBILE PHONERADIATOR

### FEATURE SELLING POINTS

- Mobile phoneradiator
- Power bank
- LED Display
- Can be added with expendable phone stand
- Built-in battery for use anywhere



### PRODUCT PARAMETERS

- Color: Black
- Available phone size: 4.7-7 inches
- Main material: ABS plastic + Lithium batteries
- Product size: 48\*85\*90mm
- Net weight: 192g
- Product power: 4.0-5.0W
- Battery capacity: 3600mAh
- Working time: 2.5-5.0h
- Charging time: 2-4h
- Working temperature: -10~50C°
- Working voltage: 3.2-4.2V
- Charging voltage: DC 5V 1-3A

# A100

## AUTO FACE TRACKING TRIPOD



### FEATURE SELLING POINTS

- Remote control
- 360° rotatable head
- Face auto-Traking
  
- RGB+Warm dual lights design
- Built-in battery for use anywhere

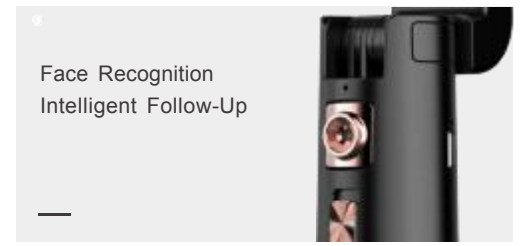

Face Recognition  
Intelligent Follow-Up



Wireless Remote Control  
Available distance 5-10m

### PRODUCT PARAMETERS

- Expandable length: 1.5m
- Available phone size: 4.7-7 inches
- Maximum load bearing capacity: 500g
- Main material: Aluminum alloy & ABS plastic
- Support system: Android, IOS, HarmonyOS
- Battery capacity(device): 1500mAh
- Folded size: 38\*70\*301mm
- Net weight: 398g
  
- Available distance(Face tracking): 3-5m
- Available distance(Remote control): 5-10m
- Battery capacity(Remote control): 55mAh
- Battery capacity(Fill light): 55mAh
- Standby time((Remote control)): 30 days
- Working temperature: -20~60C°
- Working voltage: 3.6-4.2V
- Charging voltage: DC 5V





Fill light

Extendable clip

Charging port

Automatic tracking lens

## A200 AUTO FACE TRACKING

### FEATURE SELLING POINTS

- Face auto-Traking
- Equipped with Fill light
- Equipped with Phone clip
- Can be added with expandable stand
- Small & portable
- One button to turn on for easy use
- Available elevation, horizontal and vertical shots
- Built-in battery for use anywhere



International 1/4 screws port

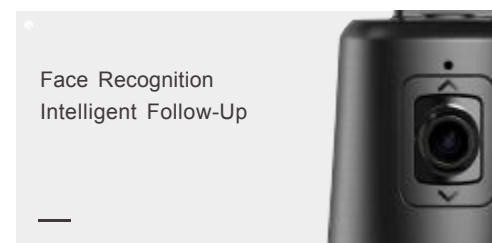

Face Recognition  
Intelligent Follow-Up

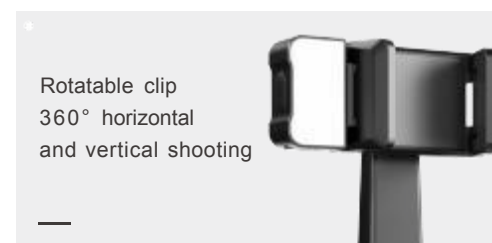

Rotatable clip  
360° horizontal  
and vertical shooting

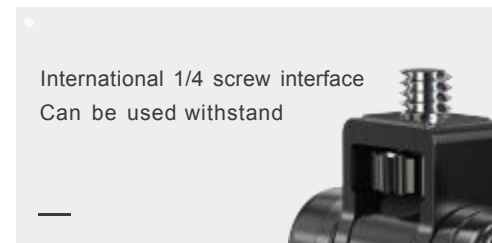

International 1/4 screw interface  
Can be used withstand

### PRODUCT PARAMETERS

- Color: Black
- Available phone size: 4.7-7inches
- Main material: ABS plastic
- Battery capacity: 1800mAh
- Product size: 59\*65\*180mm
- Product size: 93\*96\*188mm (Includes base)
- Net Weight: 240g (Includes base)
- Available distance(Face tracking): 1-3m
- Working current: 120mA-800mA
- Working voltage: 3.7V
- Charging voltage: DC 5V 2A
- Power: 3W



# PHOTOGRAPHY FILLING LIGHT

FILL LIGHT | AMBIENCE



# C10

## Multi-Function Safety Hammer Flashlight



### FEATURE SELLING POINTS

- Equipped with Seat belt cutter
- Equipped with Window Breaking Hammer
- Head can be freely turned
- Provide multi-angle lighting
  
- Equipped with flash mode & SOS mode, can be used as emergency light & warning light
- Foldable for storage
- Height adjustable
- Built-in battery for use anywhere



### PRODUCT PARAMETERS

- Main material: Aluminum alloy & ABS plastic
- Product size: 260\*37\*37mm
- Stretching size: 1080\*37\*37mm
- Net Weight: 242g
  
- Battery capacity: 800mAh
- Working time: 1.5-5.5h
- Charging time: 2h
- Working temperature: -10°~60C°
- Working voltage: 3.0-4.2v
- Charging voltage: DC 5V 1A





# D30 FILL LIGHT



## FEATURE SELLING POINTS

- With phone clip
- Multiple scenario effects modes
- Can be added with expandable phone stand
- Built-in battery for use anywhere

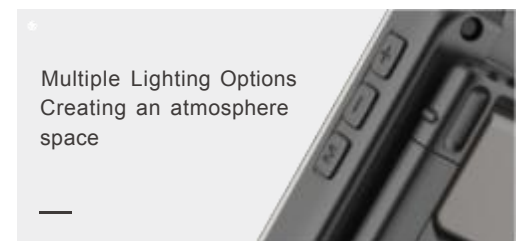
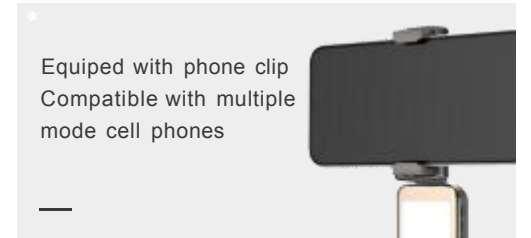

Equipped with phone clip  
Compatible with multiple  
mode cell phones

International 1/4 screw interface  
Can be used with stand

Multiple Lighting Options  
Creating an atmosphere  
space

## PRODUCT PARAMETERS

Color temperature: 3000-5000K  
Lamp beads: white 15PCS/yellow  
15PCS/RGB 18PCS  
Color rendering index: CRI 95+  
Illumination angle: 120°  
Luminosity: 400LUX/0.3m  
Product size: 115.7\*44\*26.4mm  
Net weight: 80.2g

Battery capacity: 500mAh  
Power: 3W  
Working time: 1-15h  
Charging time: 1h  
working voltage: 3.6V  
Charging voltage: 5V 1-3A  
Charging interface: Type-c



# D31

## FILL LIGHT(PLANAR LIGHT)



### FEATURE SELLING POINTS

- With phone clip
- Multiple scenario effects modes
- Can be added with expandable phone stand
- Built-in battery for use anywhere

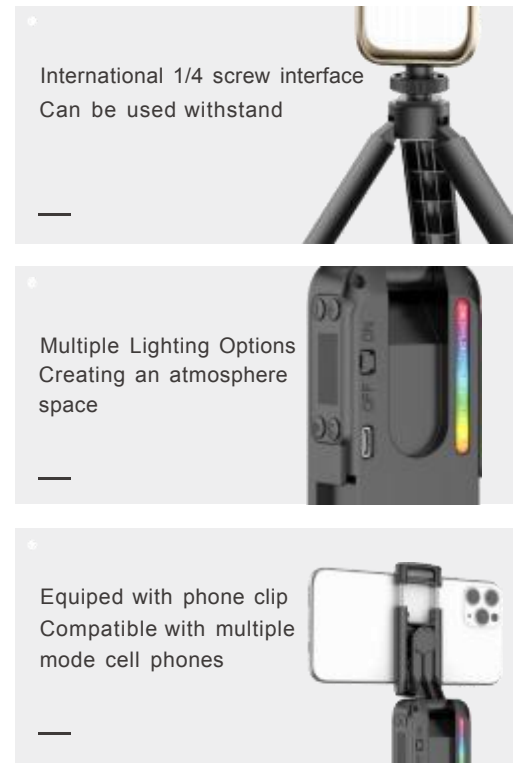

### PRODUCT PARAMETERS

- Color temperature: 2500-9000K
- Lamp beads: white 15PCS/yellow 18PCS/RGB 20PCS
- Color rendering index: CRI 95+
- Illumination angle: 120°
- Luminosity: 700LUX/0.3m
- Product size: 117.6\*52.9\*35.9mm
- Net weight: 120.8g
- Battery capacity: 2000mAh
- Power: 6W
- Working time: 1-15h
- Charging time: 2h
- working voltage: 3.6V
- Charging voltage: 5V 1-3A
- Charging interface: Type-c

# D31

## FILL LIGHT(STEREO LIGHT)

Stereoscopic light

Brightness adjustment

Switch

Charging port

Compatible Slot

LED display

International 1/4 screws port

### FEATURE SELLING POINTS

- With phone clip
- Multiple scenario effects modes
- Can be added with expandable phone stand
- Built-in battery for use anywhere

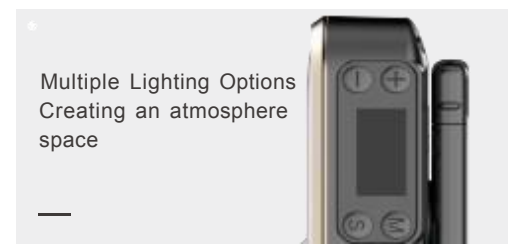
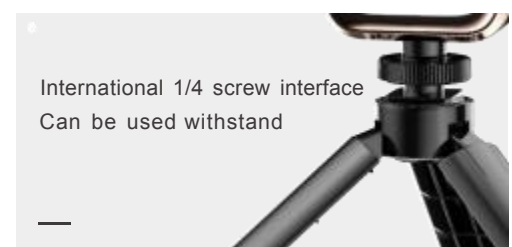
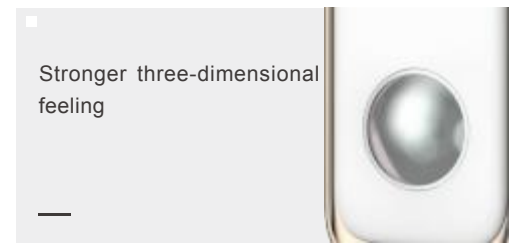

Stronger three-dimensional feeling

International 1/4 screw interface  
Can be used with stand

Multiple Lighting Options  
Creating an atmosphere space

### PRODUCT PARAMETERS

Color temperature: 2500-9000K  
 Lamp beads: white 22PCS/yellow 24PCS/RGB 1PCS  
 Color rendering index: CRI 95+  
 Illumination angle: 120°  
 Luminosity: 700LUX/0.3m  
 Product size: 117.6\*52.9\*41.1mm  
 Net weight: 121.6g

Battery capacity: 2000mAh  
 Power: 6W  
 Working time: 1-15h  
 Charging time: 2h  
 working voltage: 3.6V  
 Charging voltage: 5V 1-3A  
 Charging interface: Type-c





# C5 MACRO



## FEATURE SELLING POINTS

- Achieve closer perfect shooting effect
- Can be added with phone or computer
- Can be added with fill light

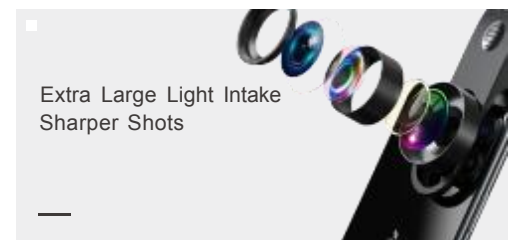
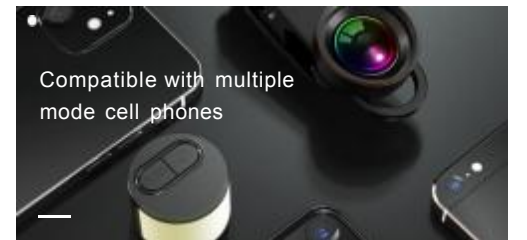

## PRODUCT PARAMETERS

Main material: ABS plastic  
 Available distance: 25-50mm  
 Product size: 124\*40\*40mm  
 Net weight: 69.5g(All)

Battery capacity(Fill light): 55mAh  
 Working time(Fill light): 30min  
 Charging time(Fill light): 50min  
 Standby time(Fill light): 30 days

Working temperature: -10~50C°  
 Working voltage(Fill light): 3.6-4.2V  
 Charging voltage(Fill light): DC 5V 2A  
 Charging interface(Fill light): Type-c



# C2/C2S

## FILL LIGHT



Fill light mask



Mounting Slot

### FEATURE SELLING POINTS

- RGB + Warm dual lights
- Multi-scene use
- Can be added with expandable phone stand
- Built-in battery for use anywhere

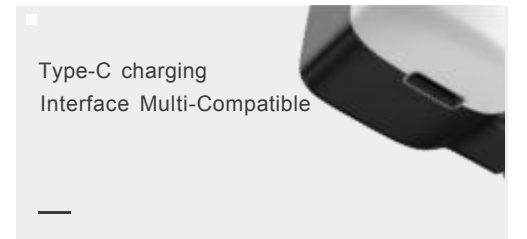

Type-C charging Interface Multi-Compatible



Large buckle design For anti-sway more stable



Small size Easy to carry



### PRODUCT PARAMETERS

Product size: 46\*41.5\*23mm  
Net weight: 17.5g(single)

Battery capacity: 55mAh  
Working time: 1-3h  
Charging time: 1-3h  
Charging voltage: DC 5V 2A  
Charging interface: Type-c

# D2B

## FILL LIGHT

### FEATURE SELLING POINTS

- Multiple scenario effects modes
- Can be added with expandable phone stand
- Can be added with 1/4 screw compatible device
- Built-in battery for use anywhere



International 1/4 screws port

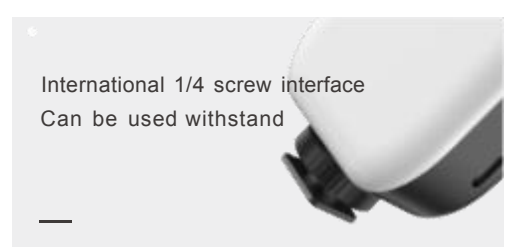
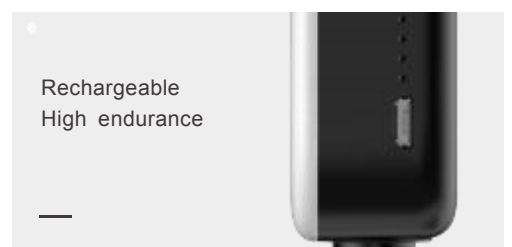

### PRODUCT PARAMETERS

Product size: 85x45x28mm  
Net weight: 50g

Battery capacity: 300mAh  
Working time: 0.5-3h  
Charging time: 1h  
Charging voltage: DC 5V 2A  
Charging interface: Type-C



# Q6

## FILL LIGHT

### FEATURE SELLING POINTS

- Multi-angle
- Multi-scene use
- Multi-size phone compatible
  
- Lightweight and easy to carry
- Can be added with 1/4 screw compatible device
- Built-in battery for use anywhere

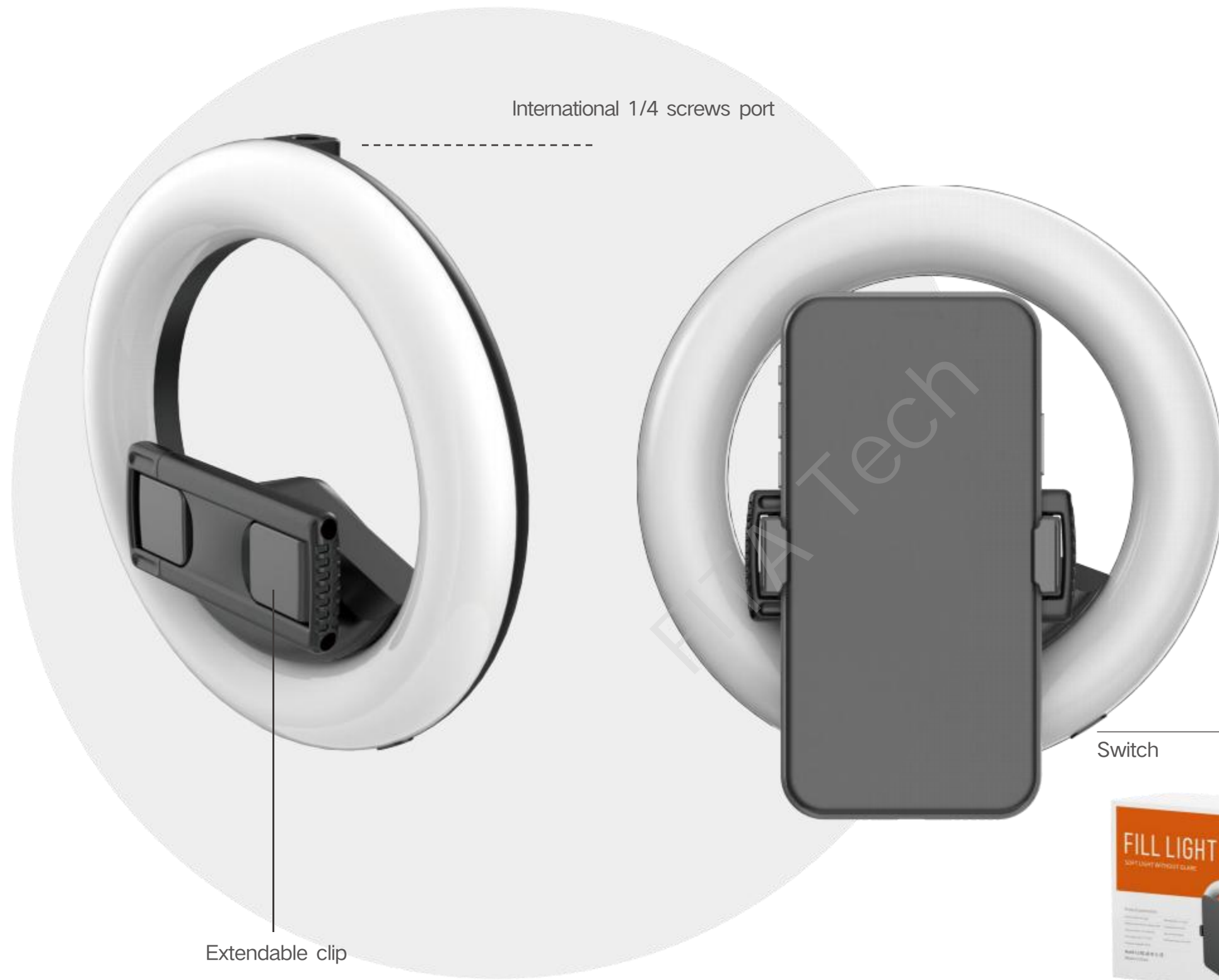

### PRODUCT PARAMETERS

Available phone size: 4.7-7 inches  
Maximum load bearing capacity: 500g  
Main material: ABS plastic + Lithium batteries  
Product size: 160\*160\*45.2mm  
Net weight: 189g

Battery capacity: 3.7V 1800mAh  
Working time: 2-17hours  
Charging time: 3h  
Working temperature: ≤50°C  
Working voltage: 0.7V-3.6V  
Charging voltage: DC 5V 2A



# Q8E

## FILL LIGHT



### FEATURE SELLING POINTS

- Multi-angle universal rotation
- Portable & Foldable storage design
- Multi-scene use
- 1.7m tall design, height adjustable
- Equipped with remote control
- Four-corner support for more stability
- Multi-size phone compatible
- Built-in battery for use anywhere



Equipped with phone clip  
Compatible with multiple  
mode cell phones



Universal shaft design  
Can be rotated at any angle

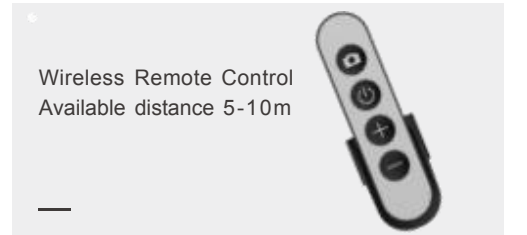

Wireless Remote Control  
Available distance 5-10m

### PRODUCT PARAMETERS

Expandable length: 1700mm  
Available phone size: 4.7-7inches  
Maximum load bearing capacity: 500g  
Main material: ABS plastic + Lithium batteries  
Folded size: 205\*78\*380mm  
Net Weight: 870g

Product power: 5W  
Battery Capacity: 3.7V 1800mAh  
Working time: 2.5-12h  
Charging time: 3h

Charging voltage: DC 5V 2A  
Color temperature: 3000/4000/5000±350K  
Color rendering index: RA≥90

# Q10

## FILL LIGHT

### FEATURE SELLING POINTS

- Portable & Foldable storage design
- Eye protection without blue light
- Can be used as a fill light for live streaming
- Multi-Angle Adjustment
- Multi-size phone compatible
- 1.64m tall design, height adjustable
- Weighted base for double stability
- Built-in battery for use anywhere

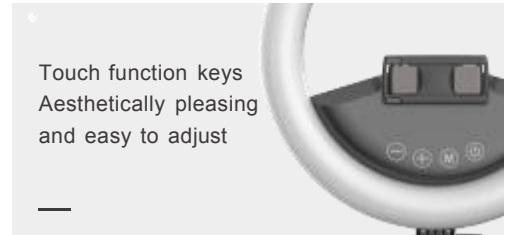
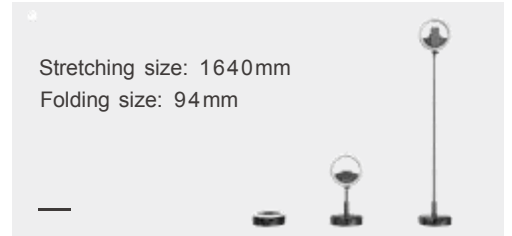
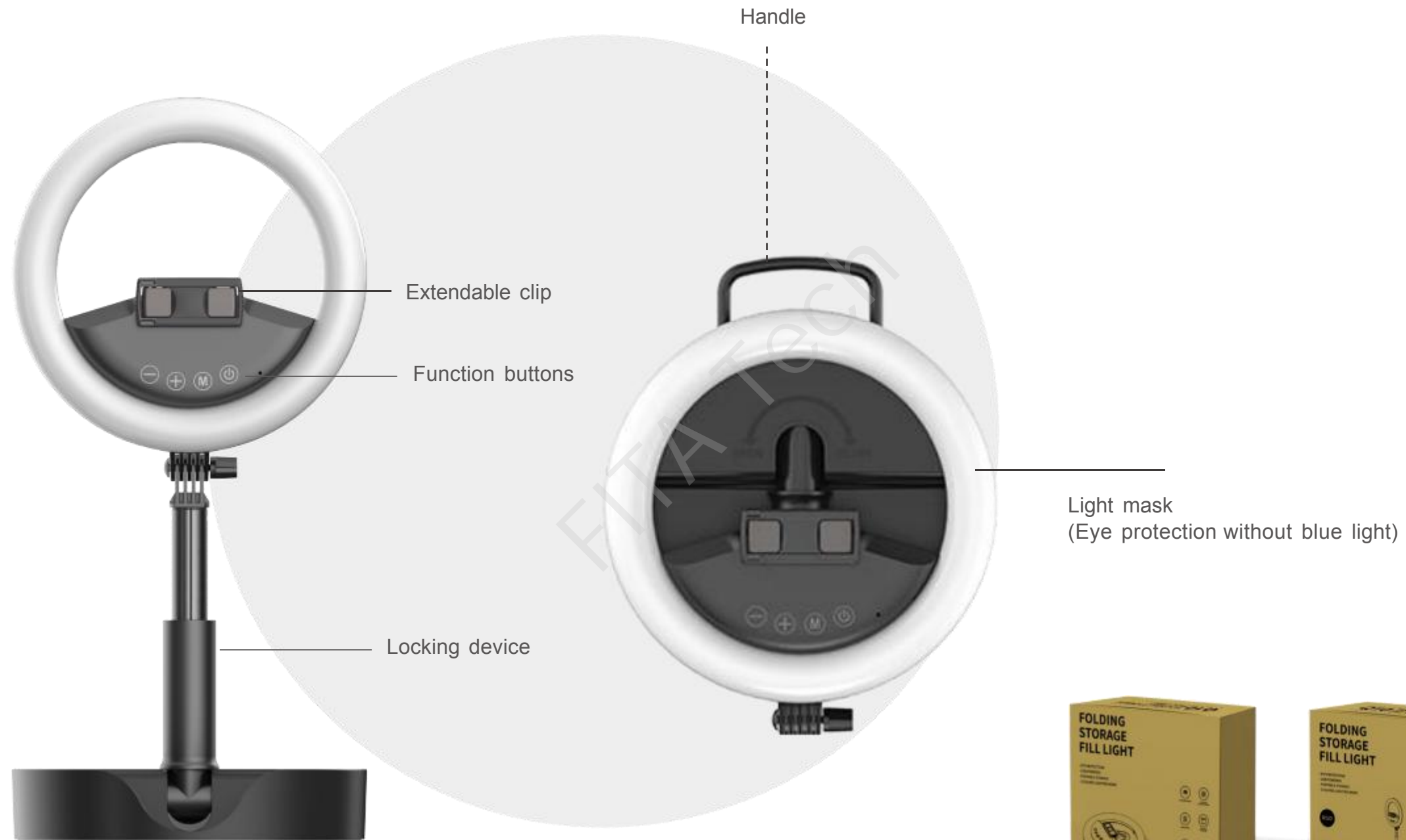

### PRODUCT PARAMETERS

- Expandable length: 1640mm
- Available phone size: 4.7-7inches
- Maximum load bearing capacity: 500g
- Main material: ABS plastic + Lithium batteries
- Folded size: 260\*316\*94mm
- Net Weight: 1.9kg
- Product power: 8W
- Battery Capacity: 3.7V 7200mAh
- Working time: 3.5-37h
- Charging time: 6h
- Charging voltage: DC 5V 2A
- Color temperature: 3000/4000/5500±350K
- Color rendering index: RA≥90



# K5

FOLDING  
STORAGE

# LAMP

Aluminum alloy

Light mask  
(Eye protection without blue light)

Function buttons

Manual locking device

### FEATURE SELLING POINTS

- Foldable storage
- Head can be flipped 180°
- Adjustable height
- Built-in battery for use anywhere

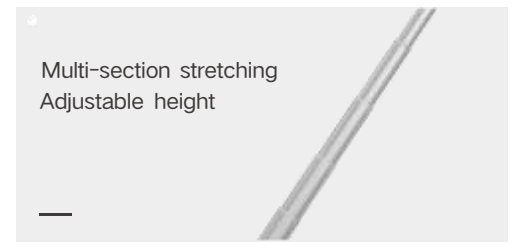

Multi-section stretching  
Adjustable height



Folding storage  
Doesn't take up  
much space



Multiple Lighting Modes  
Learning & watching for  
protecting eyes

### PRODUCT PARAMETERS

Color: white  
Expandable length: 570mm  
Main material: ABS plastic & aluminum alloy  
Folded size: 152\*152\*50mm  
Net Weight: 855g

Product power: 8W  
Battery Capacity: 3600mAh  
Working time: 2.8-20h  
Charging time: 5.5h

Charging voltage: DC 5V 2A  
Color temperature: 3000/4000/5500±350K  
Color rendering index: RA≥90  
Center illumination: ≥800



# K10

## FOLDING STORAGE LAMP

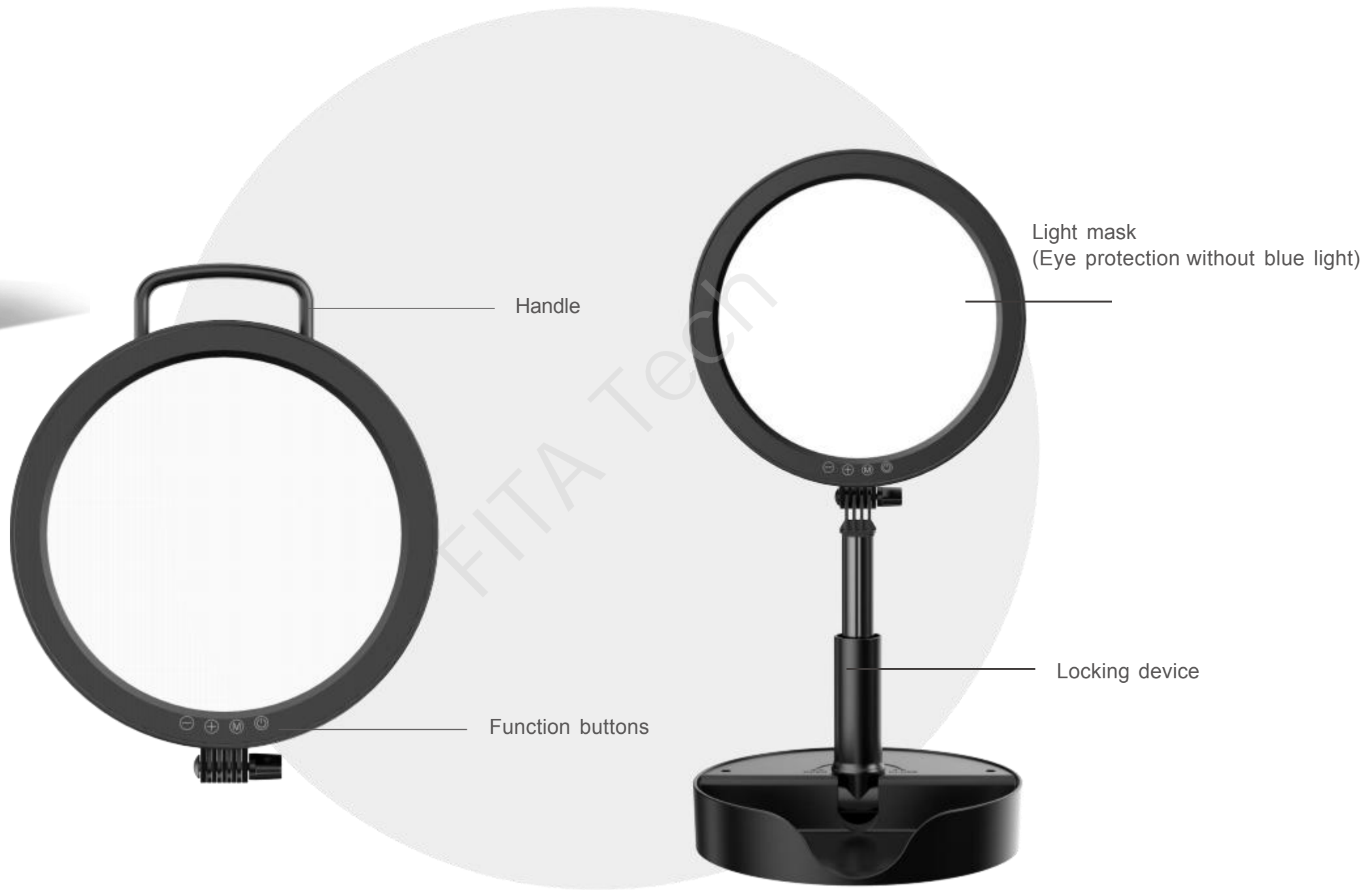

### FEATURE SELLING POINTS

- Portable & Foldable storage design
- Eye protection without blue light
- Can be used as a fill light for live streaming
- Head can be flipped 180°
- Adjustable height
- Weighted base for double stability
- Built-in battery for use anywhere

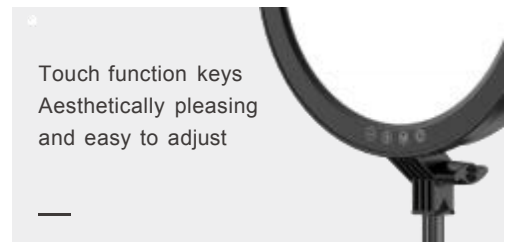

Touch function keys  
Aesthetically pleasing  
and easy to adjust



Rechargeable  
Portable



Folding storage  
Doesn't take up  
much space

### PRODUCT PARAMETERS

- Color: Black
- Expandable length: 1640mm
- Main material: ABS plastic & aluminum alloy
- Folded size: 260\*320\*65mm
- Net Weight: 2.1kg
- Product power: 8W
- Battery Capacity: 7200mAh
- Working time: 3.5-37h
- Charging time: 6h
- Charging voltage: DC 5V 2A
- Color temperature: 3000/4000/5500±350K
- Color rendering index: RA≥90



# FOLDING STORAGE FAN

FOLDABLE AND PORTABLE  
FOR GOOD STORAGE

---



# P1000

## FOLDING FAN



### FEATURE SELLING POINTS

- Portable & Foldable storage fan
- Head can be flipped 180°
- Adjustable height
- Battery level display
- Shake head, Timing(1.2.3.4), Night light
- Magnetic remote control(Rechargeable)
- Removable front cover & fan blade for easy cleaning
- Equipped with USB output port
- Built-in battery for use anywhere

Removable front cover & fan blade

Handle

Power output port

Aluminum alloy

device

Locking

Function buttons

base

Rotatable



Built-in battery  
Carrying handle



Remote Control  
Free your hands



Removable front cover & fan blade for easy cleaning

### PRODUCT PARAMETERS

- Color: white
- Size: 6 inches
- Main material: Aluminum alloy&ABS plastic
- Wind speed gear: 4 model
- Working wind speed: 2.5~4.5±0.5m/s
- Noise decibel: 10~24±5db
- Shaking angle: 60 °
- Battery capacity: 3.7V 7200mAh
- Working time: 3-35h
- Charging time: 5h
- Charging voltage: DC 5V 3A~4A
- Folding size: 198\*198\*104mm
- Stretching size: 198\*198\*1020mm
- Net Weight: 1010g±50g
- Working temperature: ≤50°C

# P2000

## FOLDING FAN



### FEATURE SELLING POINTS

- Portable & Foldable storage fan
- Head can be flipped 180°
- Adjustable height
  
- Battery level display
- Shake head, Timing(1.2.4.8), Night light
- Magnetic remote control(Rechargeable)
  
- Can be fully detachable for easy cleaning
- Equipped with USB output port
- Built-in battery for use anywhere

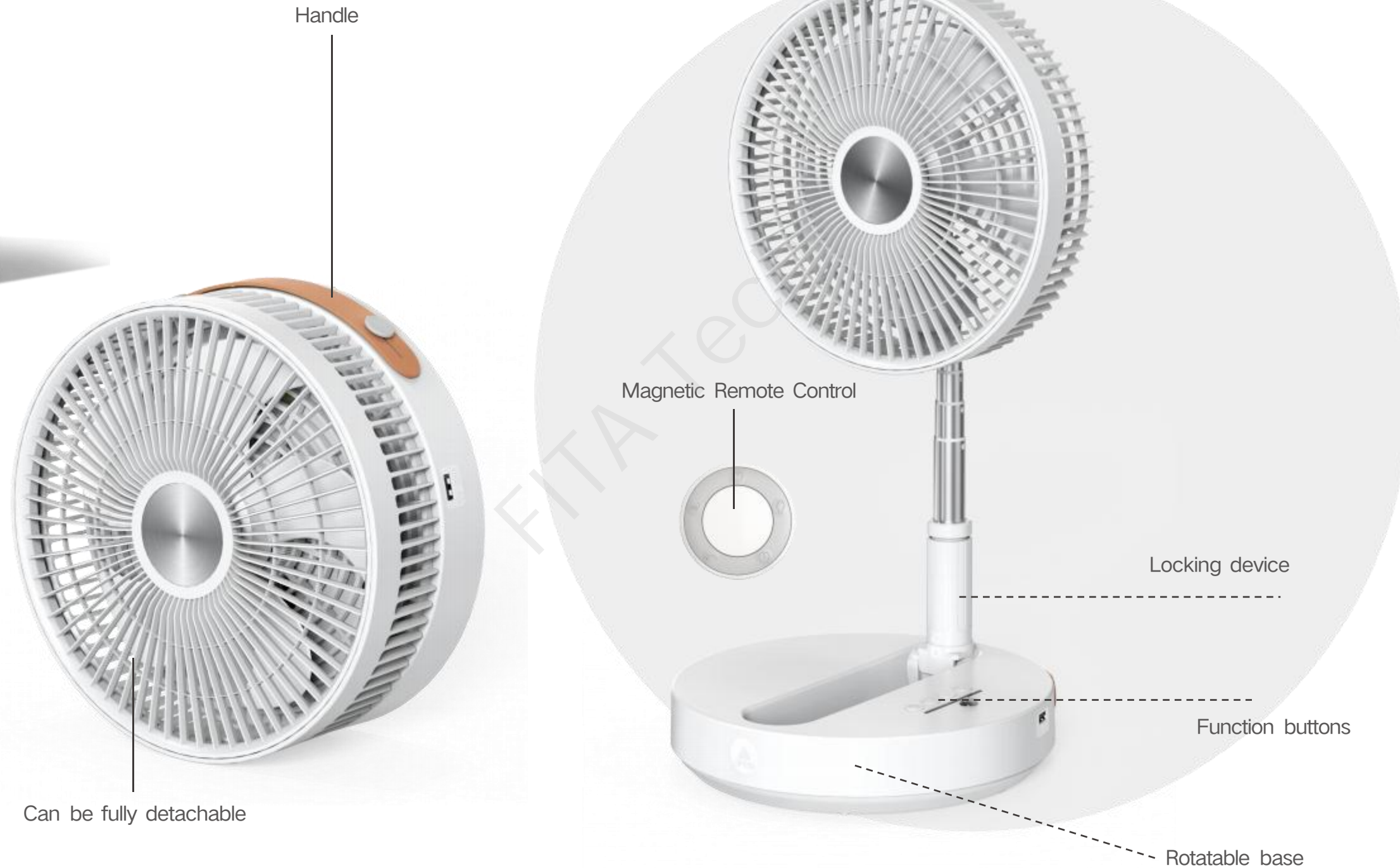

### PRODUCT PARAMETERS

- Color: white
- Size: 10 inches
- Main material: Aluminum alloy&ABS plastic
- Wind speed gear: 4 model
- Working wind speed: 2.5~4.7±0.5m/s
- Noise decibel: 10~25±5db
  
- Shaking angle: 90 °
- Battery capacity: 3.7V 10800mAh
- Working time: 6-50h
- Charging time: 5h
- Charging voltage: DC 5V 3A~4A
  
- Folding size: 250\*250\*120mm
- Stretching size: 250\*250\*980mm
- Net Weight: 1830g±100g
- Working temperature: ≤50°C



# P21

## FOLDING FAN



Storage status

Can be fully detachable

Locking device

Function buttons

Rotatable base

### FEATURE SELLING POINTS

- Foldable storage fan
- Head can be flipped 180°
- Adjustable height
- Battery level display
- Shake head, Timing(1.2.4.8)
- Remote control
- Can be fully detachable for easy cleaning
- Built-in battery for use anywhere

Can be fully detachable for easy cleaning



Wireless Remote Control Available distance 5-10m



Folding Storage Multi-Section Stretch



### PRODUCT PARAMETERS

- Color: white
- Size: 10 inches
- Main material: Aluminum alloy&ABS plastic
- Wind speed gear: 4 model
- Working wind speed: 2.8~4.2±0.5m/s
- Noise decibel: 13~23±5db
- Shaking angle: 90 °
- Battery capacity: 3.7V 7200mAh
- Working time: 3-21h
- Charging time: 5h
- Charging voltage: DC 5V 2~4A
- Folding size: 250\*250\*125mm
- Stretching size: 250\*250\*972mm
- Net Weight: 1635g±100g
- Working temperature: ≤50°C



# P30

## FOLDING FAN



Can be fully detachable

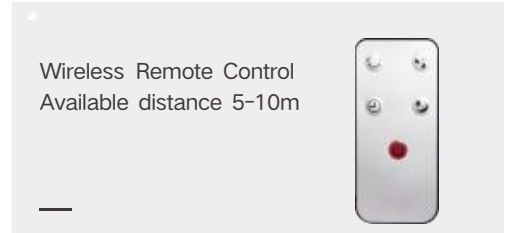
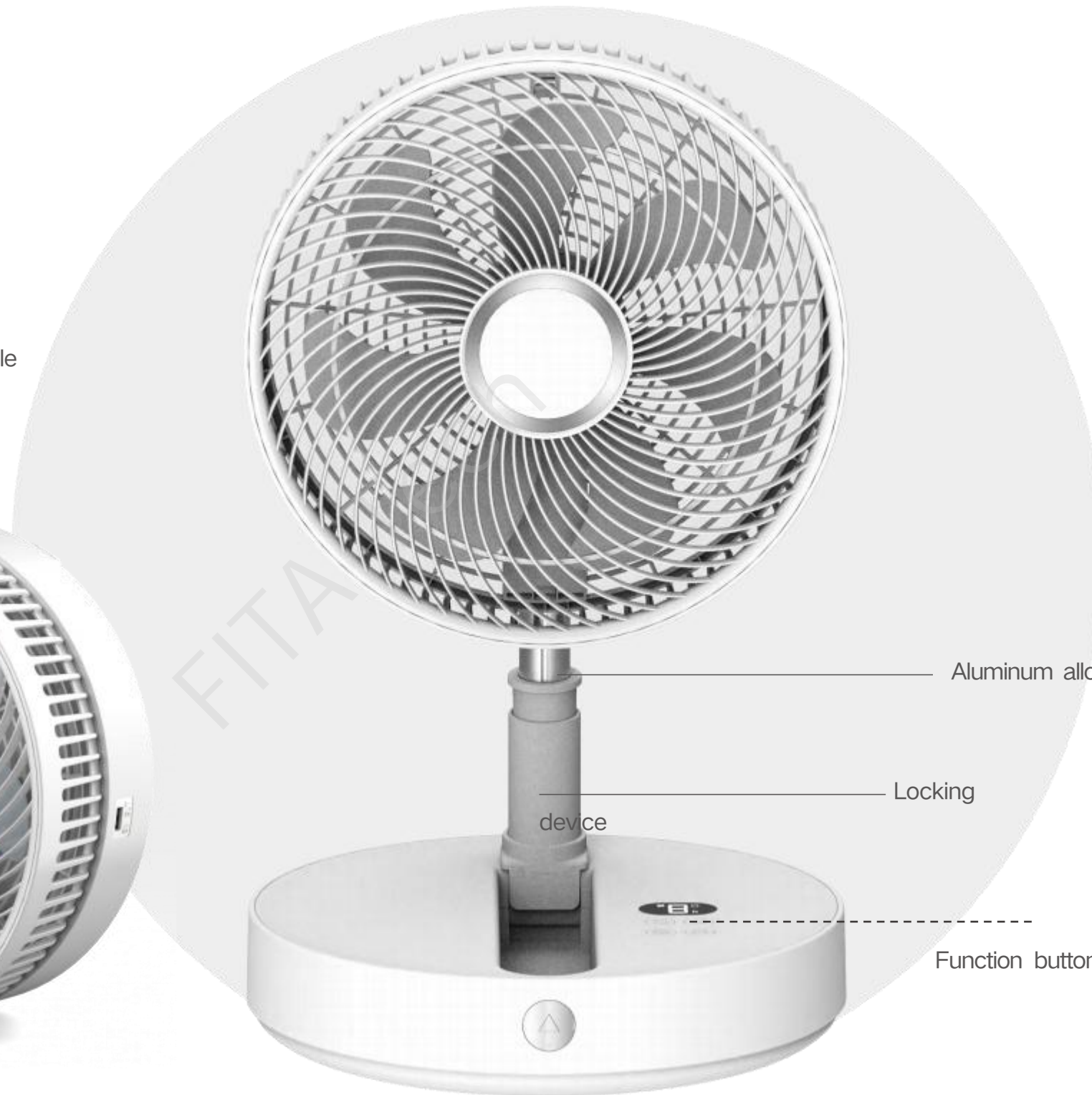

### FEATURE SELLING POINTS

- Foldable storage fan
- Head can be flipped 180°
- Adjustable height
- Battery level display
- Shake head, Timing(1.2.3.4.5.6.7.8.9) - Remote control
- Can be fully detachable for easy cleaning
- Built-in battery for use anywhere

### PRODUCT PARAMETERS

- Color: white
- Size: 12 inches
- Main material: Aluminum alloy&ABS plastic
- Wind speed gear: 8 model
- Working wind speed: 1.6~4.6±0.5m/s
- Noise decibel: 10~26±5db
- Shaking angle: 90 °
- Battery capacity: 3.7V 7200mAh
- Working time: 2-37h
- Charging time: 6-7h
- Charging voltage: DC 5V 3A
- Folding size: 300\*300\*138mm
- Stretching size: 300\*300\*1060mm
- Net Weight: 2480g±200g
- Working temperature: ≤50°C

P9

# FOLDING FAN

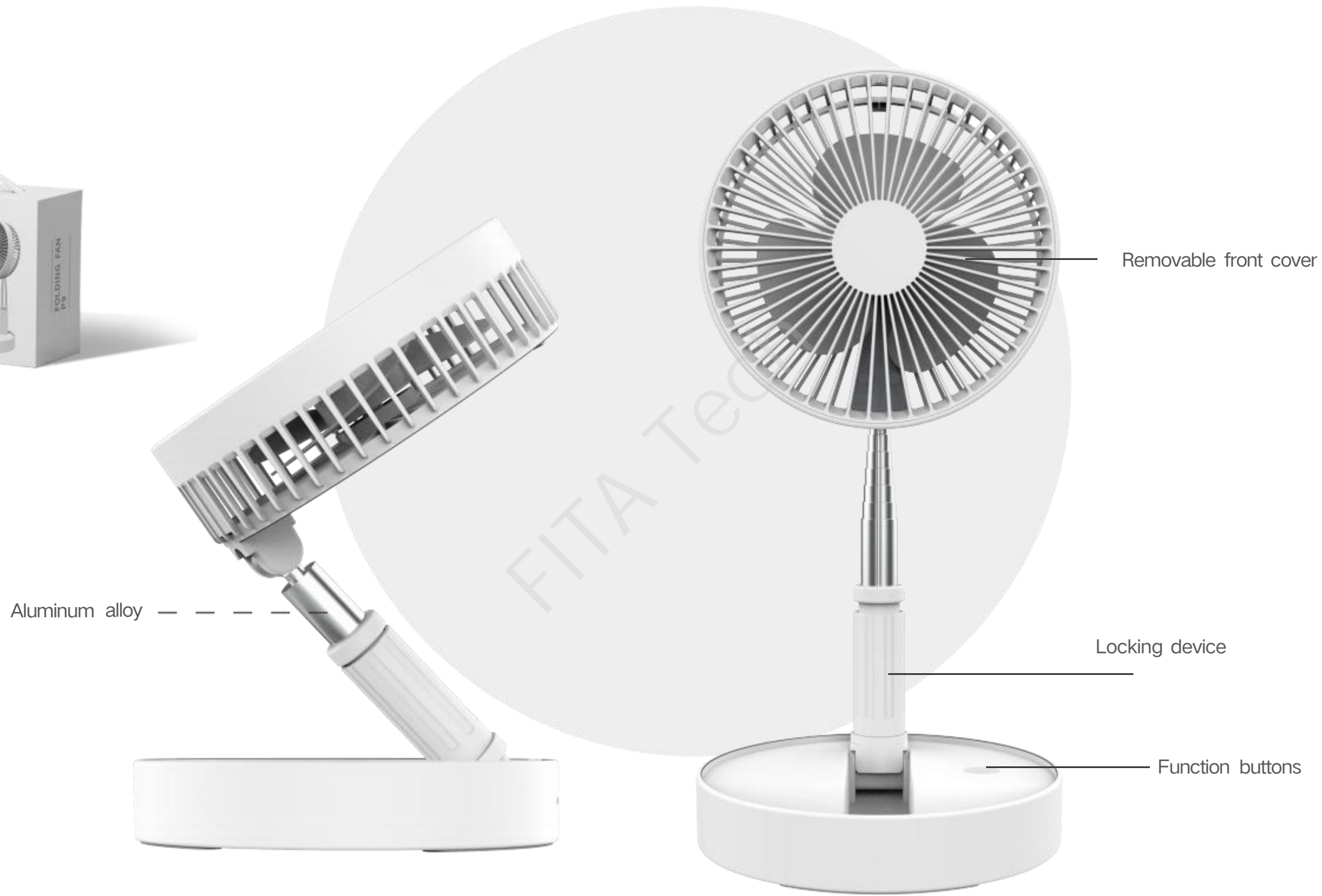

## FEATURE SELLING POINTS

- Foldable storage fan
- Head can be flipped 180°
- Adjustable height
- Removable front cover for easy cleaning
- Built-in battery for use anywhere



## PRODUCT PARAMETERS

- Color: white
- Size: 8 inches
- Main material: Aluminum alloy&ABS plastic
- Wind speed gear: 4 model
- Working wind speed: 2.54~4.0± 0.3m/s
- Noise decibel: 32~40±3 db
- Battery capacity: 3.7V 7200mAh
- Working time: 6~24h
- Charging time: 5~6h
- Charging voltage: DC 5V 2.0~2.5A
- Folding size: 197\*197\*92.5mm
- Stretching size: 197\*197\*955mm
- Net Weight: 930g±50g
- Working temperature: ≤50°C



# P9S

## FOLDING FAN



Removable front cover & fan blade

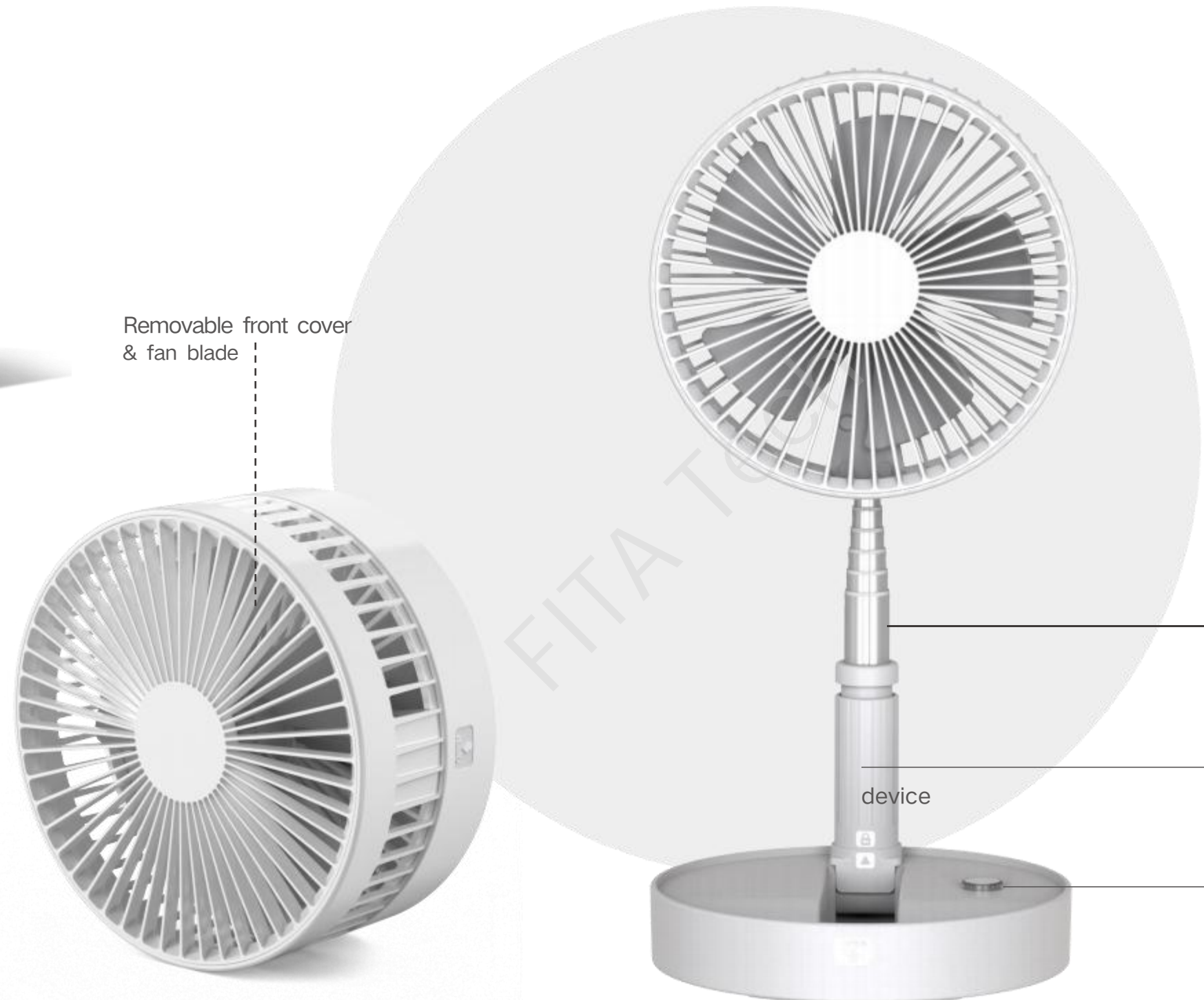

Aluminum alloy

Locking device

Function buttons



Removable front cover & fan blade for easy cleaning



Folding Storage Multi-Section Stretch

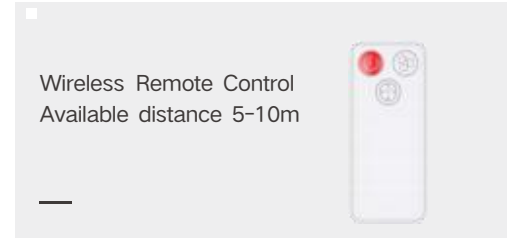

Wireless Remote Control Available distance 5-10m

### FEATURE SELLING POINTS

- Foldable storage fan
- Head can be flipped 180°
- Adjustable height
- Battery level display
- Timing(1.2.3.4)
  
- Remote control
- Removable front cover & fan blade for easy cleaning
- Built-in battery for use anywhere

### PRODUCT PARAMETERS

- Color: white
- Size: 8 inches
- Main material: Aluminum alloy&ABS plastic
- Wind speed gear: 4 model
- Working wind speed: 2.3~4.0±0.3m/s
- Noise decibel: 30~40±5db
  
- Battery capacity: 3.7V 7200mAh
- Working time: 6-24h
- Charging time: 5-6h
- Charging voltage: DC 5V 3A
  
- Folding size: 197\*197\*92.5mm
- Stretching size: 197\*197\*955mm
- Net Weight: 950g±50g
- Working temperature: ≤50°C



# P10

## FOLDING FAN



Can be fully detachable

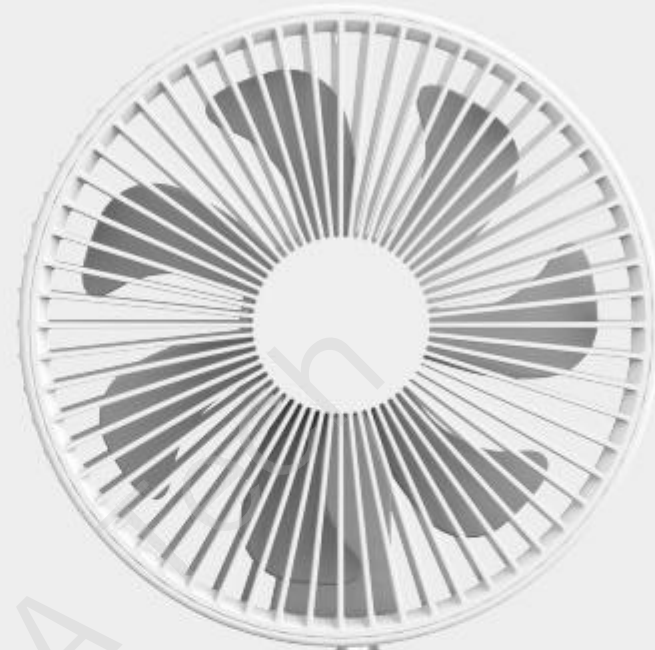

Aluminum alloy

Locking device

Function buttons

Night light

Can be fully detachable for easy cleaning

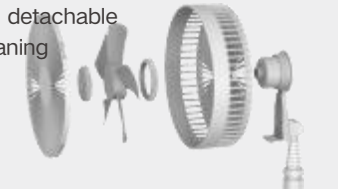

Warm night light  
Gentle eye protection



Wireless Remote Control  
Available distance 5-10m



### FEATURE SELLING POINTS

- Foldable storage fan
- Head can be flipped 180°
- Adjustable height
- Touchable button
- Battery level display
- Shake head, Timing(1.2.3.4), Night light
- Remote control
- Can be fully detachable for easy cleaning
- Built-in battery for use anywhere

### PRODUCT PARAMETERS

- Color: white
- Size: 9 inches
- Main material: Aluminum alloy&ABS plastic
- Wind speed gear: 4 model
- Working wind speed: 3.0~4.5±0.3m/s
- Noise decibel: 13~19±5db
- Battery capacity: 3.7V 10800mAh
- Working time: 7-30h
- Charging time: 6-8h
- Charging voltage: DC 5V 2A
- Folding size: 207\*207\*114mm
- Stretching size: 207\*207\*1050mm
- Net Weight: 1350g±50g
- Working temperature: ≤50°C

P11

# FOLDING FAN



Removable front cover & fan blade

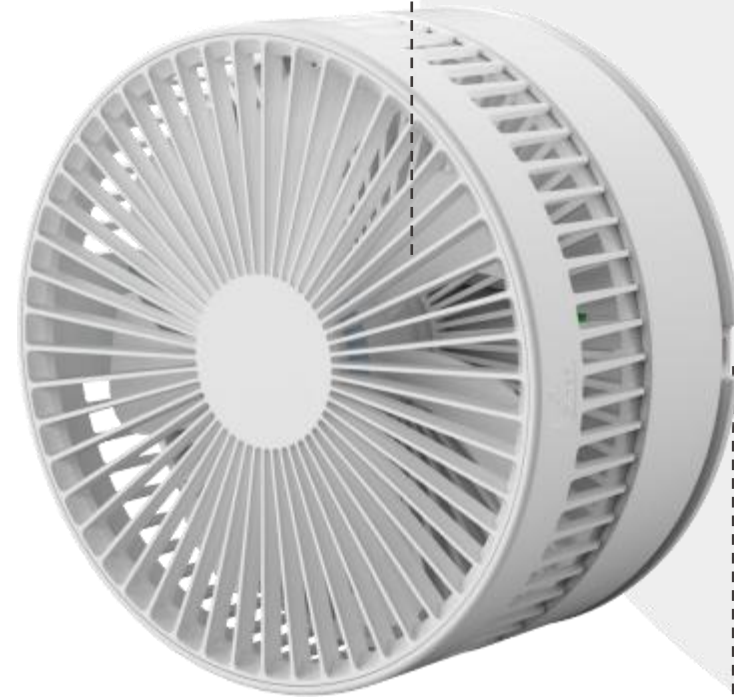

Charging port

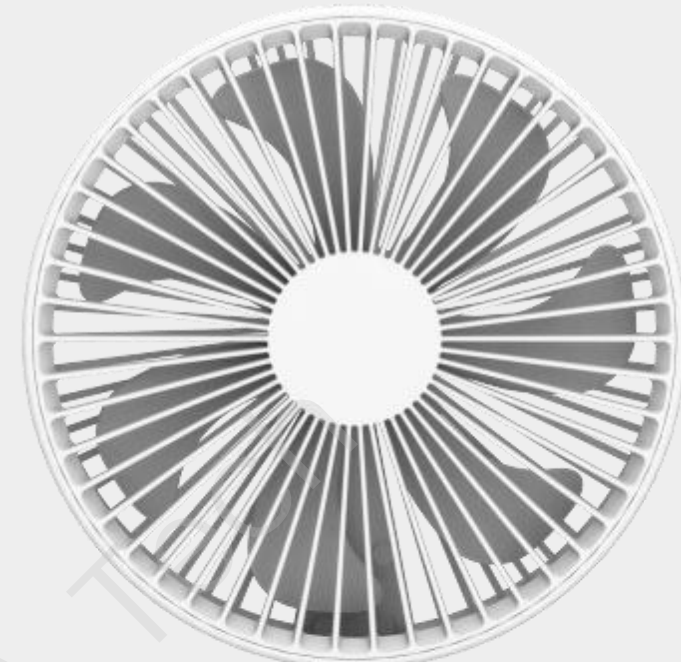

Aluminum alloy

Locking device

Function buttons

Rotatable base

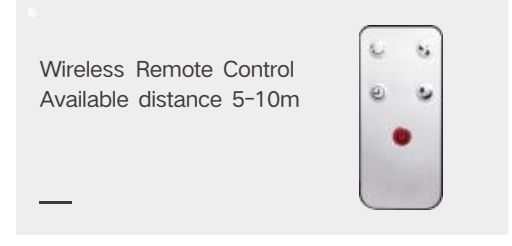

**PRODUCT PARAMETERS**

Color: white  
 Size: 8 inches  
 Main material: Aluminum alloy&ABS plastic  
 Wind speed gear: 4 model  
 Working wind speed: 3.0~4.5±0.5m/s  
 Noise decibel: 12~22±5db

Shaking angle: 60 °  
 Battery capacity: 3.7V 7200mAh  
 Working time: 3-15h  
 Charging time: 5-6h  
 Charging voltage: DC 5V 2A

Folding size: 198\*198\*104mm  
 Stretching size: 198\*198\*1000mm  
 Net Weight: 995g±50g  
 Working temperature: ≤50°C

## FEATURE SELLING POINTS

- Foldable storage fan
- Head can be flipped 180°
- Adjustable height
- Battery level display
- Shake head, Timing(1.2.3.4)
- Remote control
- Removable front cover & fan blade for easy cleaning
- Built-in battery for use anywhere

F3

FOLDING FAN



Removable front cover

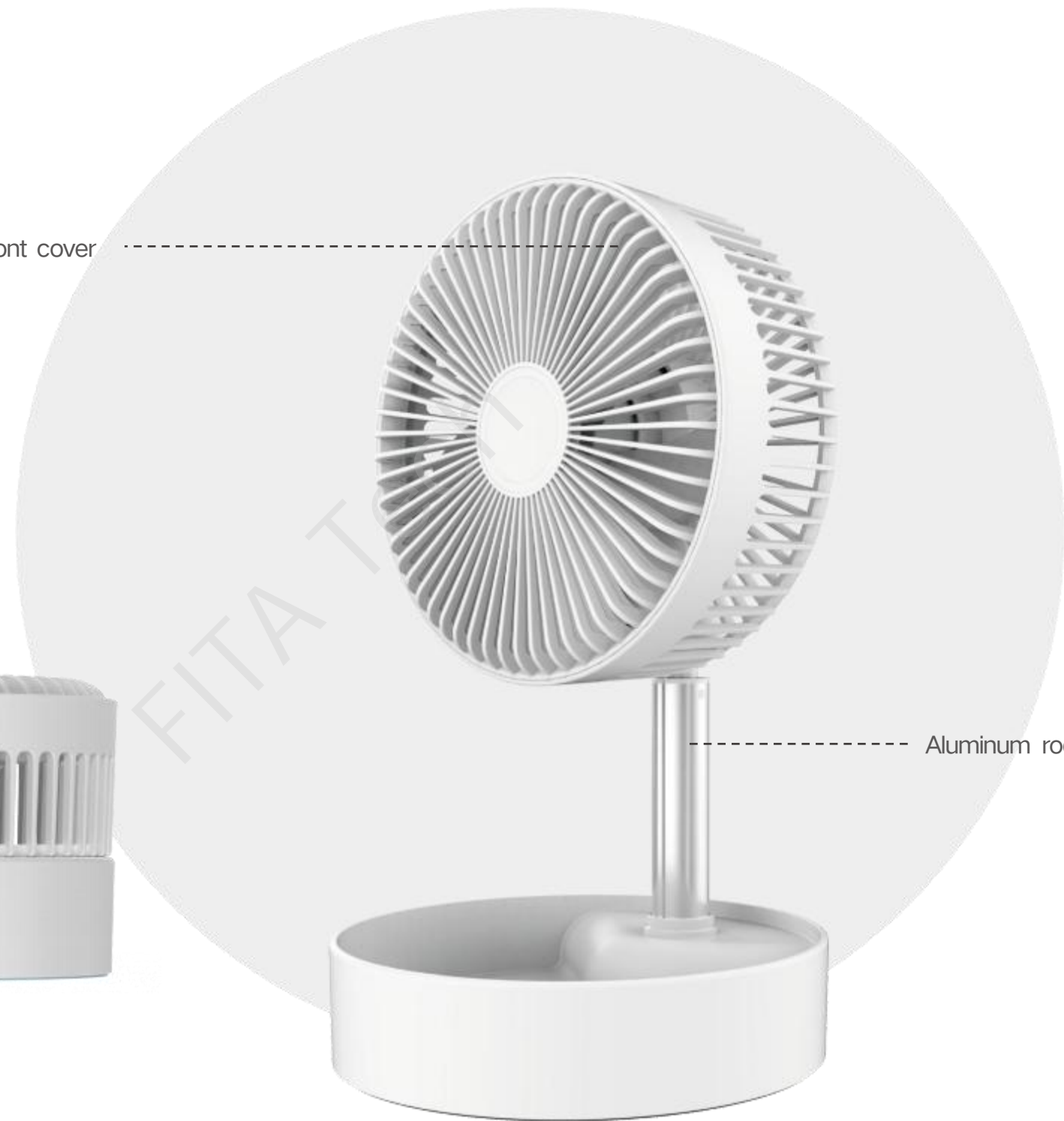
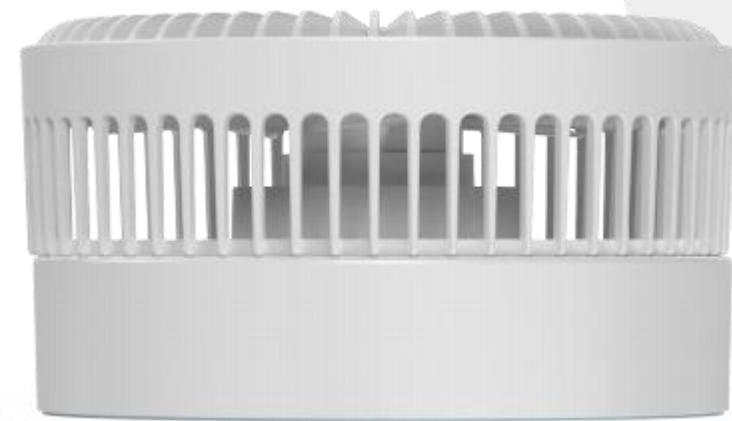

Aluminum rod

FEATURE SELLING POINTS

- Removable storage fan
- Head can be flipped 180°
- Adjustable height
- Shake head
- Removable front cover for easy cleaning

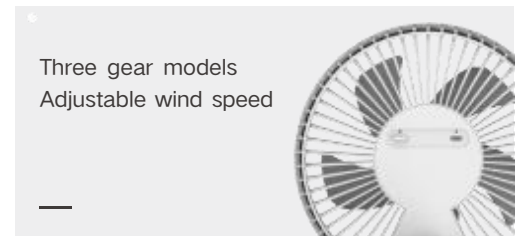

PRODUCT PARAMETERS

- Color: white
- Size: 6 inches
- Main material: Aluminum alloy&ABS plastic
- Wind speed gear: 3 model
- Working wind speed: 2.2~3.8±0.5m/s
- Noise decibel: 16~26db
- Shaking angle: 60 °
- Battery capacity: 3.7V 1800mAh
- Working time: 1~7.5h
- Charging time: 1~3h
- Charging voltage: DC 5V 1.5A
- Folding size: 181\*181\*110mm
- Stretching size: 181\*181\*860mm
- Net Weight: 1030g±50g
- Working temperature: ≤50°C



F8

FOLDING FAN



Removable front cover

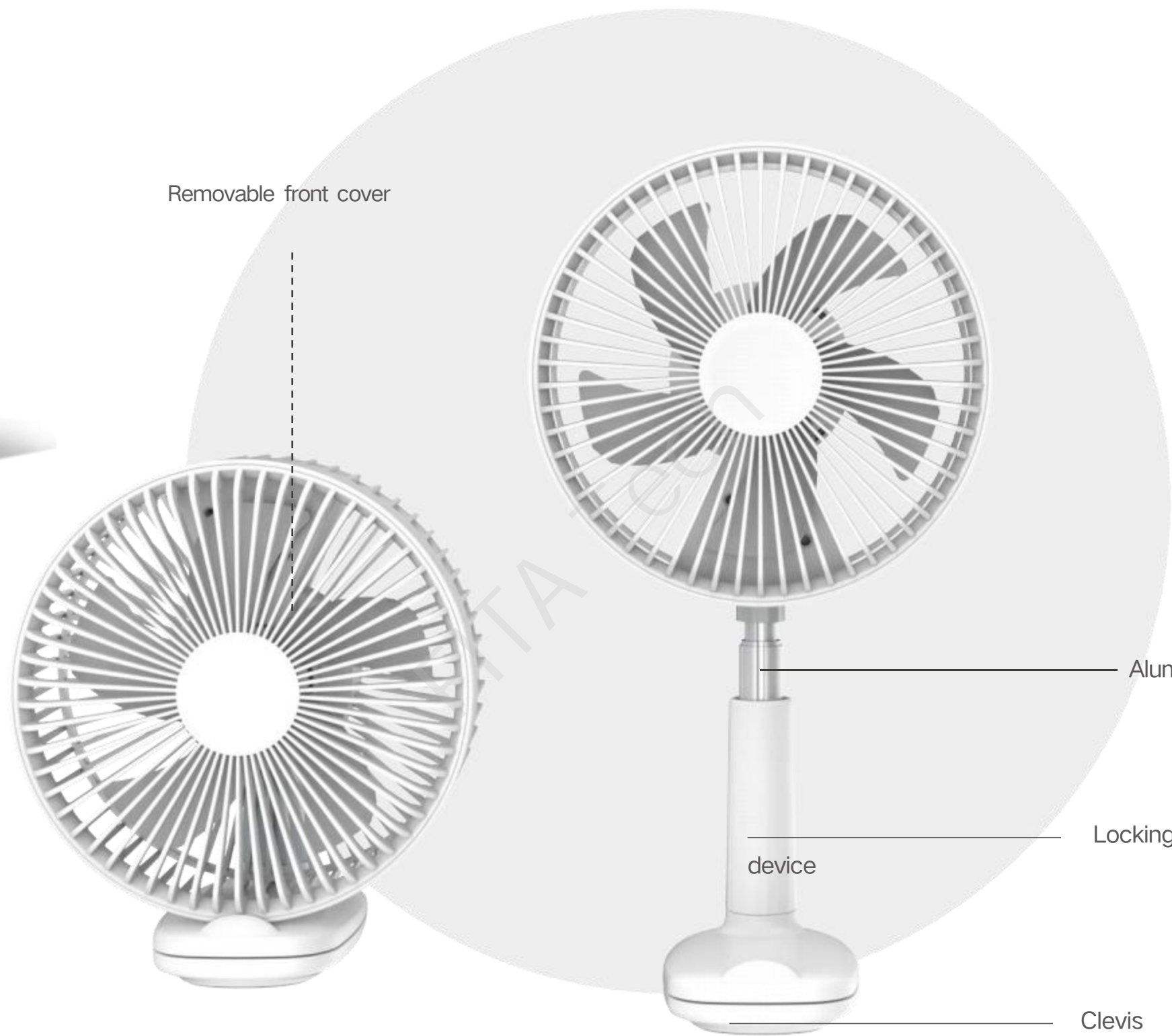

FEATURE SELLING POINTS

- Clip fan
- Head can be flipped 180°
- Adjustable height
- Shake head
- Removable front cover for easy cleaning
- Built-in battery for use anywhere

Aluminum alloy

Locking device

Clevis

Folding Storage  
Multi-Section Stretch

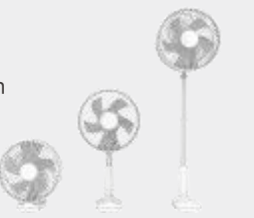

Clip design  
for use anywhere



Built-in battery  
for use anywhere



PRODUCT PARAMETERS

- Color: white
- Size: 6 inches
- Main material: Aluminum alloy&ABS plastic
- Wind speed gear: 3 model
- Working wind speed: 2.2~3.8±0.5m/s
- Noise decibel: 16~26db
- Shaking angle: 60 °
- Battery capacity: 3.7V 1800mAh
- Working time: 1~7.5h
- Charging time: 1~3h
- Charging voltage: DC 5V 1.5A
- Folding size: 181\*105\*210 mm
- Stretching size: 181\*105\*545mm
- Net Weight: 520g±50g
- Working temperature: ≤50°C



FITA Direct Supply Factory Source of Goods

FITA is your sourcing agent in China



[www.techfita.com](http://www.techfita.com)



[+86 18588730850](tel:+8618588730850)



[+86 18588730850](tel:+8618588730850)



[FITATech](https://www.instagram.com/FITATech)



[www.facebook.com/fitatech/](https://www.facebook.com/fitatech/)